



Pressure Switches

hydraulic-electronic signal converter

2 switching outputs, max. operating pressure 250 and 600 bar



Advantages

- Minimum dimensions
- Robust stainless steel measuring cell with strain gauge
- Two PNP transistor switching outputs
- Easy adjustment with 2 push-buttons
- Menu navigation as per VDMA 24574-1
- Four-digit digital display, optionally in [bar], [MPa] or [psi]
- Continuous ACTUAL pressure display
- Accuracy $\leq \pm 0.5\%$ of the measuring range
- Multi-coloured switching display for both outputs
- Many helpful additional functions

Application example

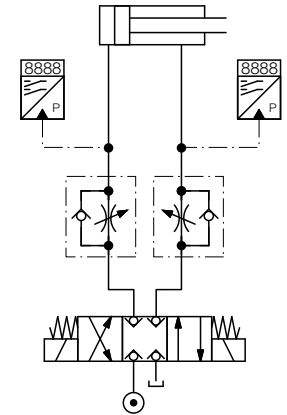

Application

Pressure switches provide an electrical switching command or signal for further work steps when a preset pressure value is reached or exceeded.

Main applications are pressure and limit value signals in hydraulics and pneumatics with high switching frequency and switching accuracy.

Description

Easily adjustable electronic pressure switch in compact design with two wear-resistant transistor switching outputs.

The switching points are set via two push-buttons using the four-digit digital pressure display. A green or red backlight indicates the switching positions of the two outputs.

For optimum adaptation to the respective application, the device offers additional setting parameters, e.g. switching delay times and break/make function of the outputs (see additional functions).

Additional functions

Break or make function selectable

Separately adjustable for both outputs.

Adjust hysteresis

A switching and a reset point can be set for each switching output. The output switches when the set switching point has been reached and switches back when the value falls below the set reset point.

Window function

The window function monitors any pressure range.

An upper and a lower switching value can be entered for each switching output, which delimit the range.

The output switches when the pressure enters this range. When leaving this range, i.e. the reset value is reached, the output switches back.

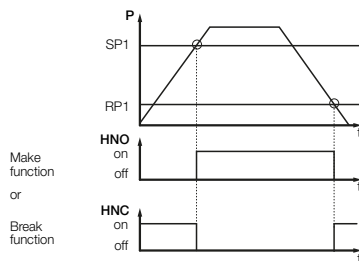

- SP1, SP2 = switching point 1 or 2
- RP1, RP2 = reset point 1 or 2
- HNO = make contact for hysteresis function
- HNC = break contact for hysteresis function

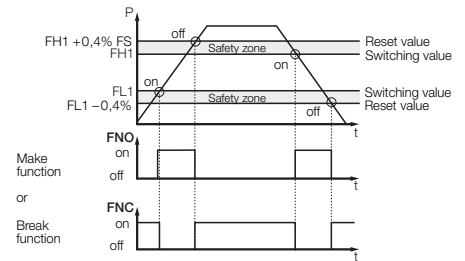

- FH1, FH2 = upper switching value 1 or 2
- FL1, FL2 = lower switching value 1 or 2
- FNO = make contact for window function
- FNC = break contact for window function

Important notes

The pressure switch must be screwed into the hexagon of the pressure connection with a wrench SW 27. With the rotatable connection adapter (accessory), the digital display can be rotated in the desired direction.

Switching and reset delay

For both outputs separately up to 99.99 s adjustable.

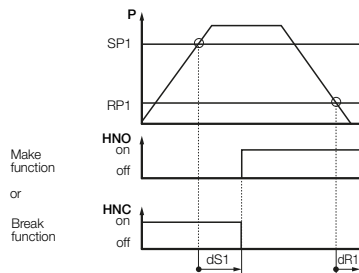

- SP1, SP2 = switching point 1 or 2
- RP1, RP2 = reset point 1 or 2
- HNO = make contact for hysteresis function
- HNC = break contact for hysteresis function
- dS1 = switching delay time, output 1
- dR1 = reset delay time, output 1

The range between switching and reset value forms a safety zone which prevents undesired switching operations.

Calming of the display value

For pressure pulsation with switchable filter.

Programming lock

Protection against unauthorized adjustment can be activated.

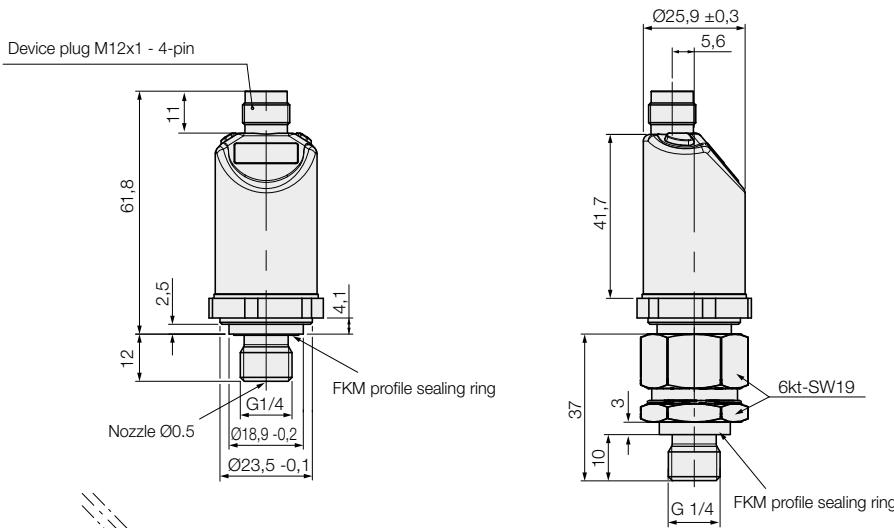

Pay attention to the angular position of the cable socket!

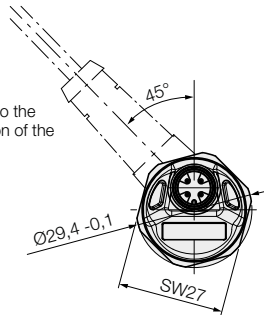

Pin assignment

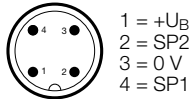

Accessory
Connection adaptor rotatable
Internal thread G 1/4
External thread G 1/4
Part no. 9208 225

Wiring diagram

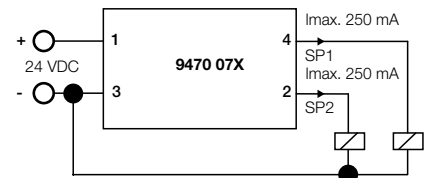

Input variables

Measuring ranges	see part no.
Supply voltage (as per UL specification)	10...32 V DC
Ripple	≤ 5 %
Power consumption max. with inactive outputs	0.535 A 35 mA

Output variables

LED display	4-digit, 7 segments
Switching outputs	2 PNP transistor switching outputs
Max. switching current	250 mA per switching output
Switching cycles	> 100 million
MTTFd	> 2 million h (228 years)
Accuracy as per DIN 16086	≤ ± 0.5 % of measuring range
Repeatability	≤ ± 0.0 % of measuring range
Response time	< 10 ms

Environmental conditions

Range of operating temperature	-25...+100 °C
Compensated temperature range	-25...+85 °C
display readability	-15...+70 °C
Vibration resistance (0...500 Hz)	approx. 10 g
Shock resistance (11 ms)	approx. 50 g
Code class as per DIN EN 60529	IP 67

Other variables

Hydraulic connection	G1/4 ISO 1179-2 with 0.5 mm nozzle	
Recommended tightening torque	20 Nm	
Connector	stainless steel	
Sensor cell	thin-film strain gauge	
Weight, approx.	0.07 kg	
Measuring range	2.5...250 bar	6.0...600 bar
Overload range	500 bar	1000 bar
Part no.	9740073	9740075

Accessory

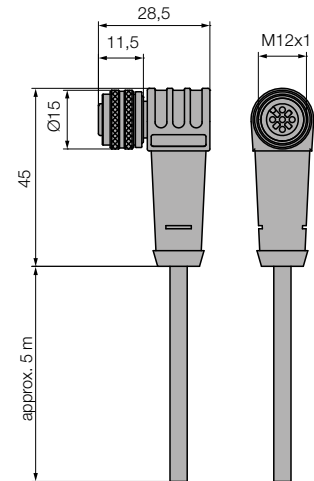

Cable socket M12x1 angled
Shielded cable
Cable length approx. 5 m
4 wires Lif9YH11YH 4x0.34 mm²
Sheat Ø 5.1 mm
Part no. 3829 282