

Work Supports

contact by spring force or air pressure,
single acting, max. operating pressure 500 bar

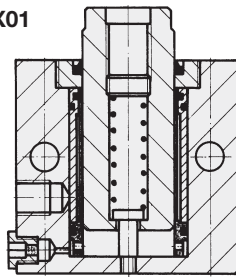

192X X01



192X X02

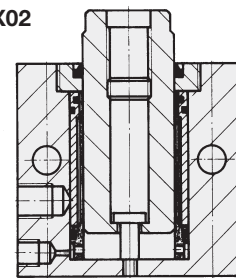

192X X03

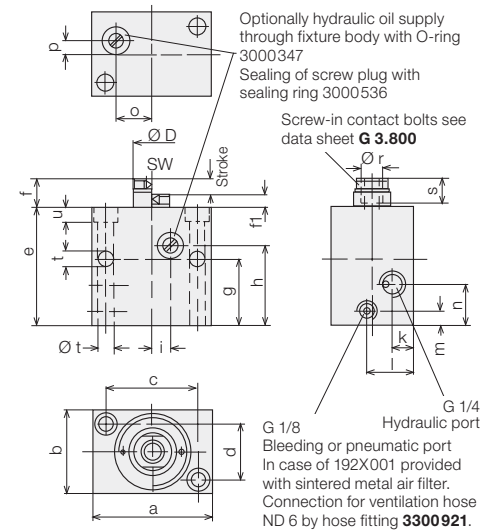
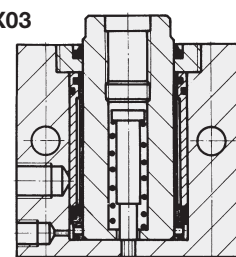

Application

Hydraulic work supports are used to provide a self-adjusting rest for the workpiece during the machining operations. They compensate the workpiece surface irregularities, also deflection and vibration under machining loads.

Installation

The universal block cylinder shape allows vertical and horizontal mounting, with oil feed via normal pipe connection or by manifold mounting direct to the fixture through drilled channels in the fixture body.

Function

Hydraulic locking is made together with hydraulic clamping of the workpiece, or independently. The support plunger is provided with female thread to enable the use of threaded pieces for height adjustment.

There are three variations of plunger actuation:

- 1. Spring advanced;** plunger extended in off-position
 - 2. Air pressure advanced;** without spring return
 - 3. Air pressure advanced;** with spring return
- The pneumatically-actuated plunger allows precise setting of the plunger contact force by means of a pressure reducing valve. If a danger exists of sucking fluids through the pneumatic port, on the spring-advanced unit, a vent hose should be connected.

Important notes

Work supports are not suitable to compensate side loads.
Operating conditions, tolerances and other data see data sheet A 0.100.
It is absolutely necessary to follow the instructions for venting of the spring area on data sheet G 0.110.

Admissible load F as function of the operating pressure p

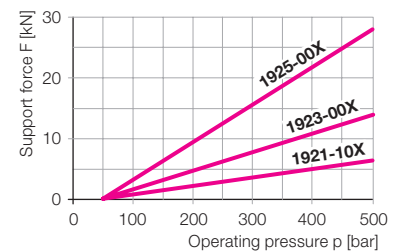

Plunger Ø D	[mm]	16	20	35
Stroke	[mm]	6	8	10
Support force at 500 bar	[kN]	7	12.5	28
Spring force min.	[N]	8	13.5	19.2
Spring force max.	[N]	10	17	24
Plunger contact force at 1 bar air pressure (deduct spring force if necessary)	[N]	20.1	31.4	96.2
Recom. min. oil pressure	[bar]	100	100	100
a	[mm]	60	65	85
b	[mm]	35	45	63
c	[mm]	40	50	63
d	[mm]	22	30	40
e	[mm]	56	64	79
f	[mm]	12	15	20
f1	[mm]	6	7	10
g	[mm]	26	36	39
h	[mm]	36	43	52
i	[mm]	7	10	12
k	[mm]	12.5	11.5	20.5
l	[mm]	17.5	25.5	39.5
m	[mm]	8.5	8	8
n	[mm]	38	22	25
o	[mm]	14.5	19	25
p	[mm]	5	7	11
Ø r	[mm]	M 10	M 12	M 16
s	[mm]	14	14	21
Ø t	[mm]	6.5	8.5	10.5
u	[mm]	6	8	10
SW	[mm]	13	17	27
Weight	[kg]	0.8	1.2	2.6
Part no.				
Extended by: Spring force		1921 101	1923001	1925001
Air pressure		1921 102	1923002	1925002
Air pressure with spring return		1921 103	1923003	1925003
Accessories Screw plug G 1/4		3610264	3610264	3610264
O-ring 10x2		3000347	3000347	3000347
Spare seal ring		3000536	3000536	3000536
Contact bolt, dome head (see G 3.800)		3614002	3614028	3614003