



**ROEMHELD**  
HILMA ■ STARK



# HILMA.NC

Modular machine vice  
for flexible production

jaw widths 100, 125 and 160 mm



**ROEMHELD**  
HILMA ■ STARK



# STARK INNOVATIVE PROFICIENT INDIVIDUAL SAFE

The high-tech company STARK Spannsysteme was established in 1977 in Rankweil, Austria. It manufactures zero point clamping systems and vices of the highest quality and precision for international clients in the automotive, aviation and medical industries, for example.

STARK Spannsysteme products are a byword for minimal set-up times, faster production and high flexibility.

HILMA vices can be complemented and combined perfectly with STARK zero point clamping systems.

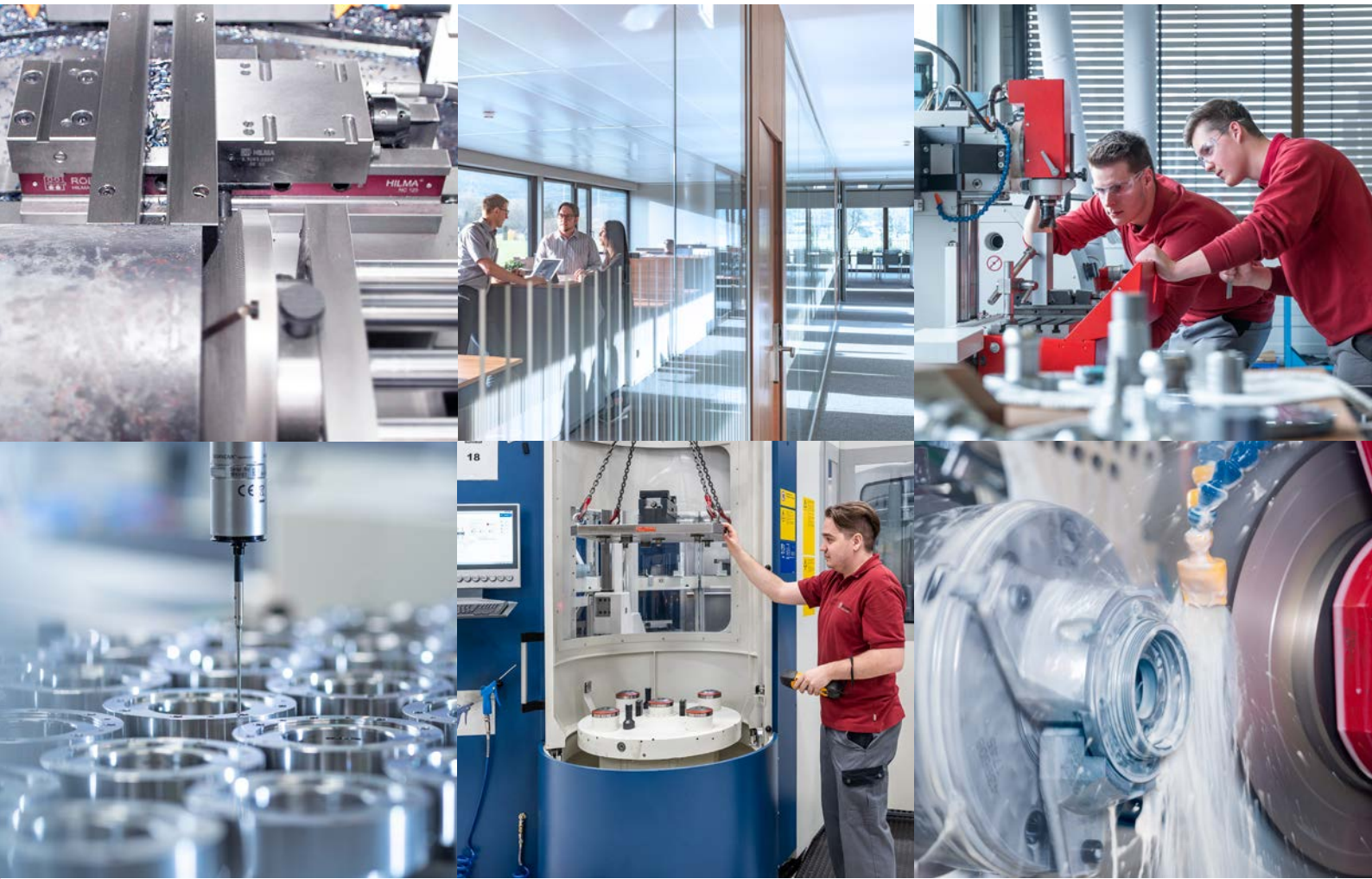

AUTOMOTIVE



AVIATION



MACHINE AND TOOL  
CONSTRUCTION



MEDICINE

# FOCUS ON INDUSTRIES & MARKETS.

Every customer has specific requirements. Our established and extensive industry expertise allows us to offer you the best solutions, services and products for sustainable and efficient use in your market.

# HILMA.NC

**ADAPTED  
MODULAR  
FIXED  
SAFE  
CLEAN**

three jaw widths and variable base lengths  
extensive range of jaws and accessories  
optimal possibilities for fixation  
precise and constant clamping force  
easy cleaning

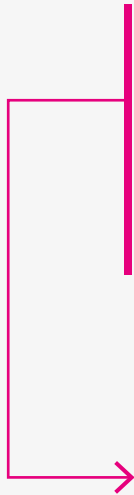

HILMA.NC



HILMA.DS



HILMA.KNC



HILMA.ASH



HILMA.ASE

**AUTOMATION**

## HILMA Workpiece clamping systems

More productivity through:

- maximum flexibility in production
- highest process reliability
- reduced manufacturing costs through set-up time optimisation

**VERTICAL MACHINING**

**HORIZONTAL MACHINING**

**5-AXIS MACHINING**



HILMA.SCT



HILMA.TS Vector



HILMA.TS TriStar



HILMA.MCP



HILMA.UC



HILMA.SCS



## HILMA.NC TABLE OF CONTENTS

<b>Modular machine vice</b>	<b>6</b>	<b>Options for fixation on the machine table</b>	<b>36</b>
The variable basis	8	Zero point clamping system - retractable nipple	37
Function & advantages <b>HILMA.NC</b>	10	Zero point clamping system - Fast closing plates	38
Function & advantages <b>HILMA.NCH</b>	12	Clamping claws & keyblocks	39
<b>HILMA.NC series - mechanically operated</b>	<b>14</b>	<b>Accessories</b>	
<b>HILMA.NC 100</b>	15	Crank handle, extension for crank handle,	
<b>HILMA.NC 125</b>	16	angle drive with crank handle	40
<b>HILMA.NC 160</b>	17	Precision workpiece stop	40
 		Clamping force preselection, oil filler nipple, load cell	41
<b>HILMA.NCH series - hydraulically operated</b>	<b>18</b>	Hydraulic power unit	
<b>HILMA.NCH 100</b>	19	 	
<b>HILMA.NCH 125</b>	20	<b>Order number list</b>	<b>42</b>
<b>HILMA.NCH 160</b>	21		
<b>Individual machine vice</b>			
Flat rate reworking	22		
Customised designs	23		
<b>Extensive range of jaws</b>	<b>24</b>		
Clamping jaws	26		
PinFlex clamping jaws	30		
SlimFlex jaw system	31		
Top jaws	32		
QIS quick-change jaws	34		

# HILMA.NC

## Modular machine vice

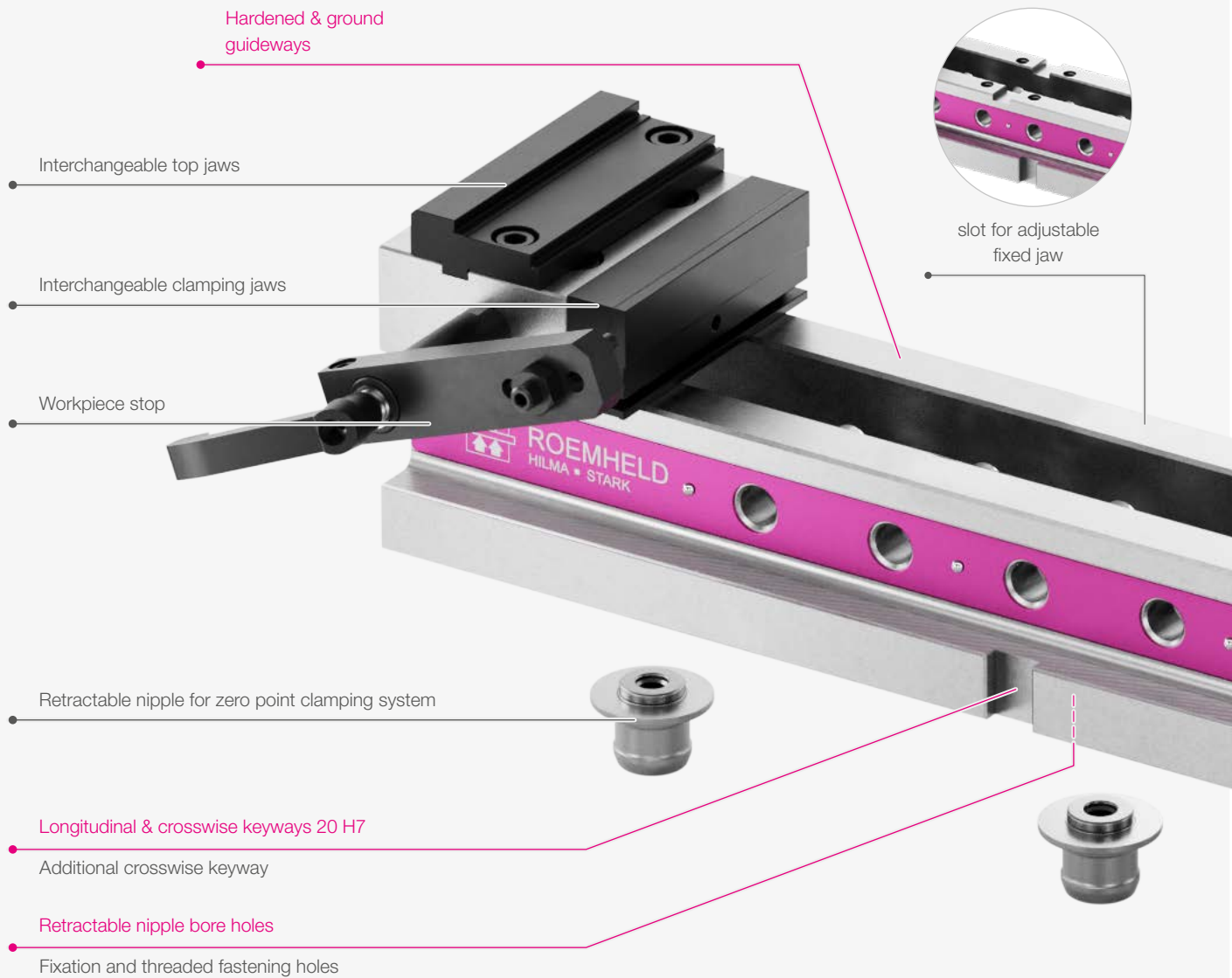

—● Basic machine vice

—● Customised rework or optional accessories



## HILMA.NC

Mechanically operated with hydraulic force transmission



## HILMA.NCH

Hydraulically operated

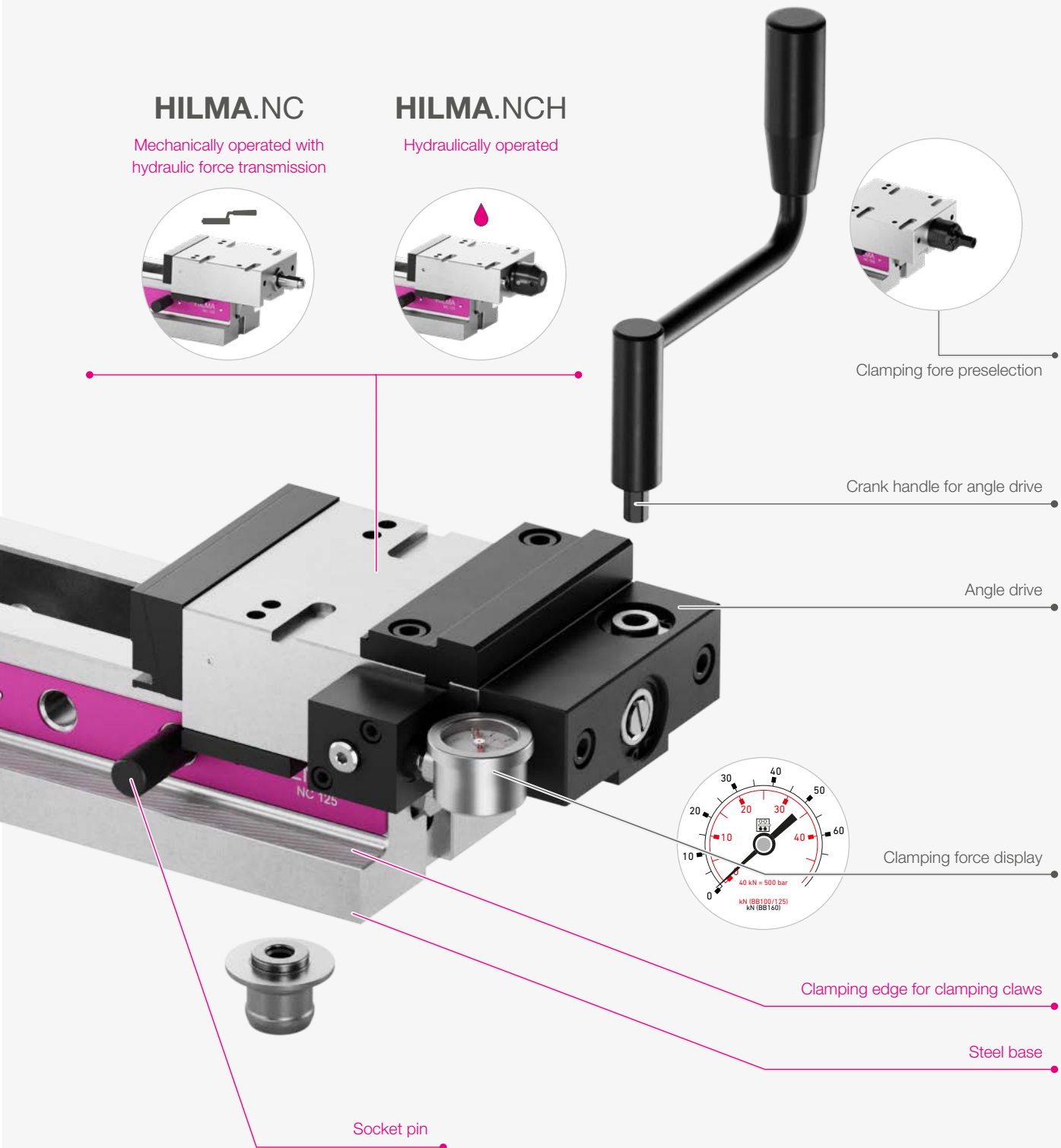

## THE VARIABLE BASIS

# The **HILMA.NC** machine vice

The modular system of the **HILMA.NC** series is preferably used on vertical machining centres.

Depending on the machining strategy and degree of automation, the clamping force can be applied manually by means of a crank handle (**HILMA.NC**) or hydraulically by means of a power unit (**HILMA.NCH**).

Different jaw widths & variable base lengths ensure optimum adaptation to the existing circumstances such as machining task, machine & environment.

The extensive range of jaws rounds off the flexible clamping system.

The base of the vice can be fixed to the machine table by means of a zero point clamping system, clamping claws or screws and pins.

Optional rework on the base of the machine vice allows additional positioning and fixation options.

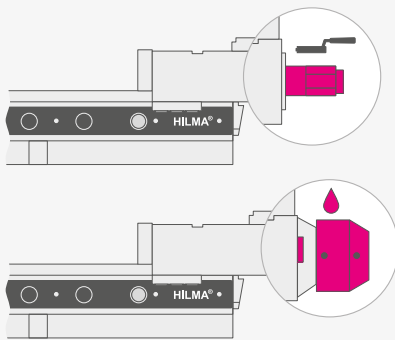

### Operation options

#### **HILMA.NC**

- Manually by means of crank handle and hydraulic force transmission
- + Linear, continuously variable force build-up by means of a crank handle

▶ more on page 10

#### **HILMA.NCH**

- Hydraulically using a power unit, e.g. by means of a hand/foot switch, Machine-controlled
- + Semi-automated processes, improved ergonomics, short clamping and release times

▶ more on page 12

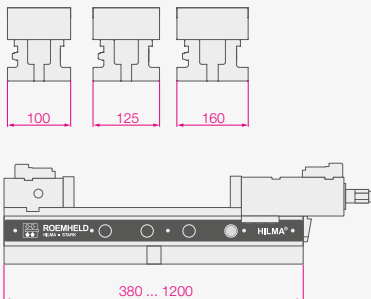

### Jaw widths & base lengths

- Three jaw widths 100, 125 and 160 mm
- Up to five standard lengths per jaw width from 380 to 1200 mm
- + Optimum adaptation of the clamping system to the machine and clamping task

- Individual desired lengths up to 1200 mm possible

▶ more on page 23



## Range of jaws

- Very extensive standard range of jaws for the most diverse clamping tasks
- + Blank and finished part clamping
- + For workpieces in all shapes from round to square and from small to large
  
- Magnetic quick-change jaws (QIS - Quick Insert System)
- + Jaw change in seconds without tools with QIS jaws
  
- Customised clamping jaws on request

▶ more on page 24

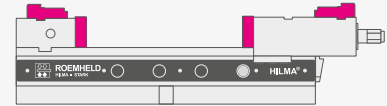

## Fixation, positioning & quick change

- Fixation using lateral clamping claws
- Fixation from above through the base by means of screws and pins
- Quick change by means of retractable nipple directly or using adapter plate in the zero point clamping system
- Customised fixation and positioning bore holes in the base of the vice according to parameter specifications or as rework possible
  
- Retractable nipple bore holes in the base as standard
- Standard fast closing plates available

▶ more on page 36

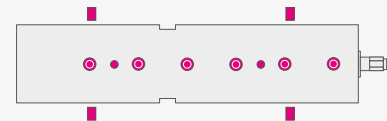

## Socket pin

Pulling out the socket pin allows the clamping slide to move freely:

- A coarse adjustment of the clamping range
- + Quick slide adjustment, without prolonged actuation of the crank handle
  
- Easy removal of the clamping slide
- + Without clamping slide, the base can be cleaned easily and quickly
- + Easy to service

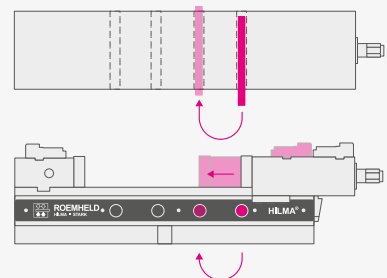

MECHANICALLY OPERATED MACHINE VICE

Function & advantages **HILMA.NC**

The **HILMA.NC** mechanical/hydraulic machine vice is designed for tool, mould and fixture construction as well as for production and is suitable for small to medium batch sizes.

**Mechanical operation**

**with hydraulic force transmission**

- ▶ Requires a minimum cranking force
- ▶ No external pressure generator necessary
- ▶ Hydraulic slides can be retrofitted

**Optional accessories**

- ▶ Clamping force display
- ▶ Clamping force preselection
- ▶ Angle drive, ...

**INFO**

Hydraulic force transmission for mechanical operation

①

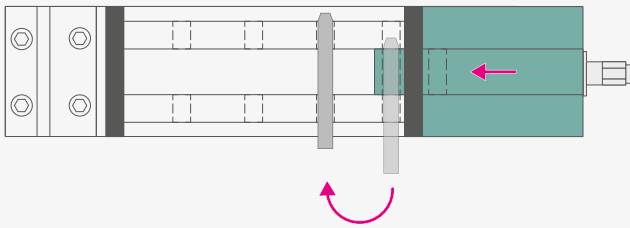

- ① By pulling out the socket pin, the clamping slide can be moved freely and allows a coarse adjustment of the clamping range.

②

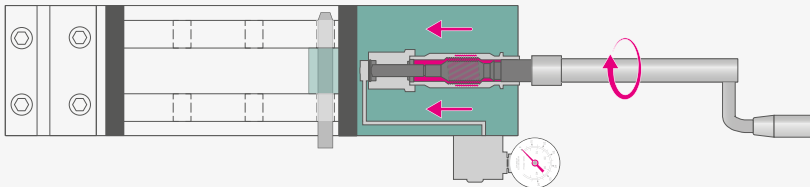

- ② The workpiece is finely adjusted manually using a threaded spindle (crank handle). By turning the threaded spindle clockwise, the slide is mechanically fed to the component. Clamping is not yet established.

③

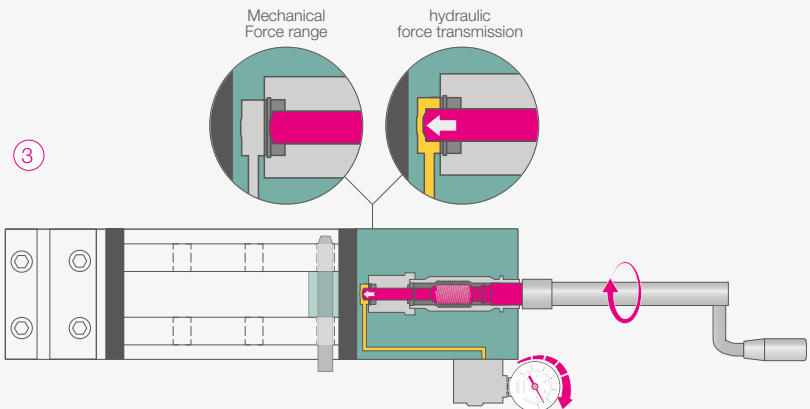

- ③ After a noticeable resistance (disengagement of the index bolt), the hydraulic clamping force builds up (linearly up to the maximum) and ensures a tight fit of the workpiece. Cranking requires little effort due to the hydraulic clamping force build-up.

- ▶ Release: By turning the crank handle anti-clockwise until the the index bolt engages causes a continuous reduction of the clamping force. When turning further, the machine vice is opened.



### Clamping force display

- Continuous display of the clamping force
- Continuous and exact application of the clamping force
- When using clamping jaws with a coating or grip serration, controlled clamping is only possible in conjunction with a clamping force display
- + Optimisation of operation through precise reproducibility of the clamping force
- + No deformation of the workpieces due to exact application of the clamping force
- + High process reliability - continuous clamping force display
- + Roughing and finishing in one arrangement

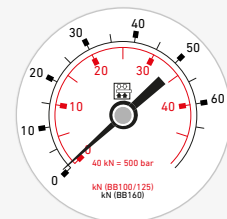
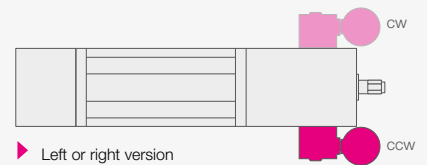

### Clamping force preselection

- Mechanical limitation of the clamping force build-up to a fixed value in 6 steps
- + reduces the deformation of the components and reduces operating errors

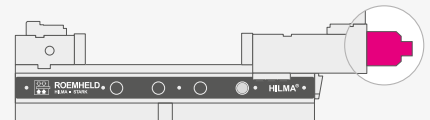

### Angle drive

The alternative actuation option using the angle drive with crank handle enables ergonomic operation when access is difficult.

- Recommended from a base length of 540 mm
- Retrofittable

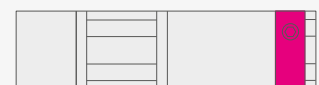
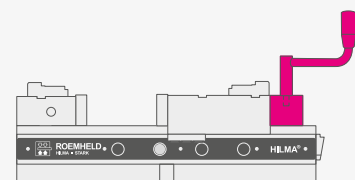

▶ Clamping force display, clamping force preselection and angle drive only for mechanically operated series, not for HILMA.NCH

HYDRAULICALLY OPERATED, SINGLE-ACTING MACHINE VICE

Function & advantages **HILMA.NCH**

The **HILMA.NCH** hydraulic machine vice is designed for use in semi-automated operation and series production and is preferably used on vertical machining centres.

The hydraulic series has advantages for medium to large batch sizes with short machining cycles.

**Hydraulic operation**

- ▶ Single-acting
- ▶ Connection to power unit or machine hydraulics
- ▶ By means of foot switch, hand switch, machine control system
- ▶ 5 mm stroke for jaw widths 100, 125  
7 mm stroke for jaw width 160

**Optional accessories**

- for safe and easy handling
- ▶ Crank handle extension
  - ▶ Hydraulic units, ...

**INFO**

Hydraulic operation

①

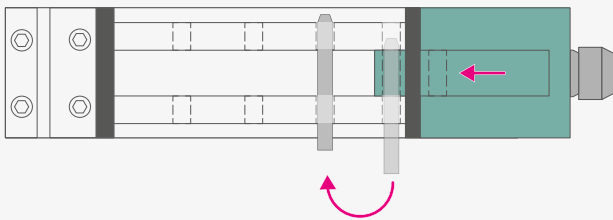

- ① By pulling out the socket pin, the clamping slide can be moved freely and allows a coarse adjustment of the clamping range.

②

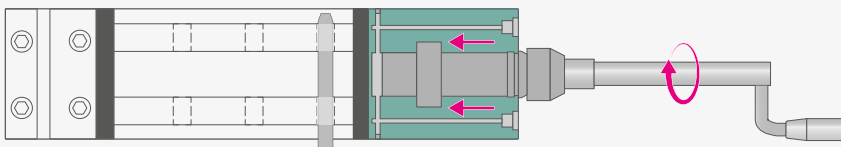

- ② Fine adjustment up to the hydraulic stroke is achieved by means of a crank handle. By turning the threaded spindle clockwise, the slide is mechanically fed. Clamping is not yet established.

③

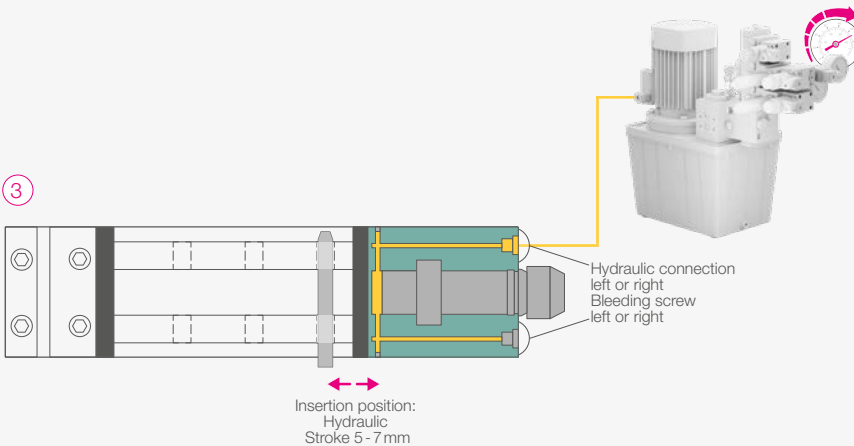

- ③ Actuation is achieved using an external pressure generator. This can be the machine hydraulics or a separate power unit. By switching on the hydraulics, the clamping force is built up according to the preadjusted operating pressure (bar).

- ▶ Insertion position: fast, automated release and clamping with hydraulic stroke



### Semi-automated workpiece change in series production

The semi-automatic workpiece change in production enables fast, efficient and safe handling of workpieces, resulting in higher productivity and quality.

- Several clamping locations on a machine table can be actuated simultaneously via a trigger - with process reliability and repeat accuracy.
- Actuation by means of the foot switch enables two-handed loading and unloading of large-volume or heavy workpieces.

- + Improved working conditions and ergonomics: the operator's workload is reduced
- + Efficient production: increased throughput, time and cost savings, minimised downtime
- + Flexible production: quick changes between different workpieces
- + Higher product quality due to semi-automated handling

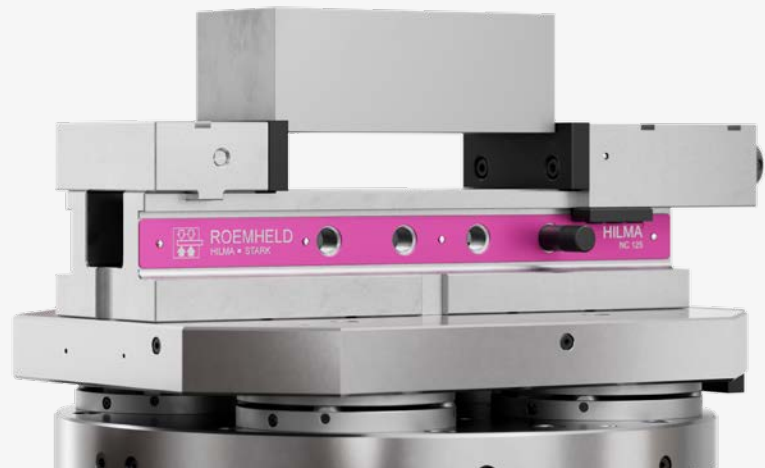

### Clamping force/clamping pressure

- The clamping force is set on the hydraulic unit via the hydraulic pressure
- + The clamping force is applied with repeat accuracy, operating errors are minimised
- + Increased process reliability - the clamping force is monitored on the power unit and corrected if the clamping situation eases off

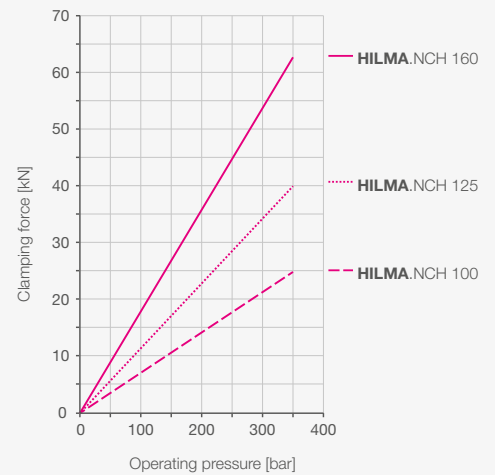

MACHINE VICE  
 MECHANICALLY OPERATED WITH HYDRAULIC FORCE TRANSMISSION

# HILMA.NC series

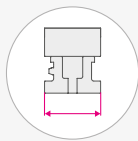

Jaw width

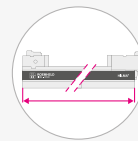

Base lengths\*

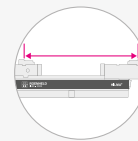

max.  
Jaw openings

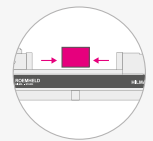

Clamping force

## HILMA.NC 100



100mm	380mm 540mm	386mm 546mm	25 kN
-------	----------------	----------------	-------

## HILMA.NC 125



125mm	430mm	431mm	40 kN
	560mm	561mm	
	720mm	721mm	
	1000mm	1001mm	
	1200mm	1201mm	

## HILMA.NC 160



160mm	550mm	572mm	50 kN
	750mm	772mm	
	1000mm	1022mm	
	1200mm	1222mm	

\* Customised base versions and intermediate lengths possible ► more on page 22 & 23

**HILMA.NC 100**

The **HILMA.NC 100** is a mechanical/hydraulic machine vice with a jaw width of 100mm.



Figure: 930720203  
Standard scope of supply  
Machine vice incl. crank handle and clamping jaws

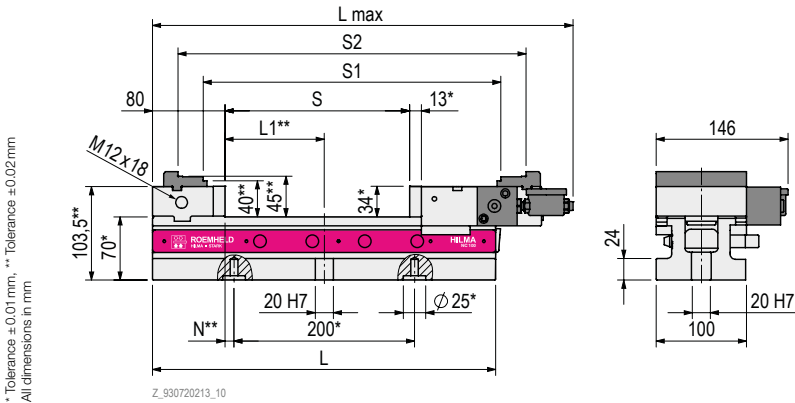
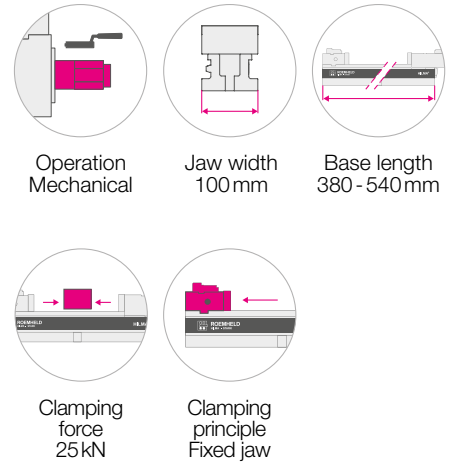

Series		HILMA.NC 100.380	HILMA.NC 100.540
Operation		mechanical	
Base length L <sup>1)</sup>	[mm]	380	540
Clamping force	[kN]	25	
Clamping principle		against fixed jaw	
Clamping range S <sup>2)</sup>	[mm]	0–205	0–365
Clamping range S1 <sup>3)</sup>	[mm]	125–330	125–490
Clamping range S2 <sup>3)</sup>	[mm]	181–386	181–546
Max total length L	[mm]	466	626
Partial length L1	[mm]	110	190
Retractable nipple bore hole	[mm]	25	
Retractable nipple bore holes	[pcs.]	2	3
Retractable nipple bore spacing	[mm]	200	
Retractable nipple bore hole for fixed jaw N	[mm]	10	-10
Weight with standard clamping jaws	[kg]	18.5	23.5
Part no.		930720203	930720303
Order no. with clamping force display L		930720213	930720313
Order no. with clamping force displayR		930720214	930720314

<sup>1)</sup> Customised base versions and intermediate lengths possible ▶ more on page 22 & 23  
<sup>2)</sup> with standard clamping jaws (scope of supply)  
<sup>3)</sup> with top jaws ▶ more on page 32

**HILMA.NC 125**

The **HILMA.NC 125** is a mechanical/hydraulic machine vice with a jaw width of 125 mm.



Figure: 930730203  
Standard scope of supply  
Machine vice incl. crank handle and clamping jaws

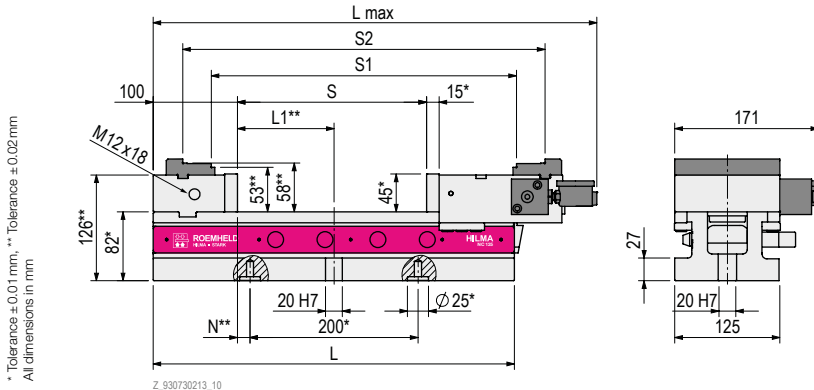
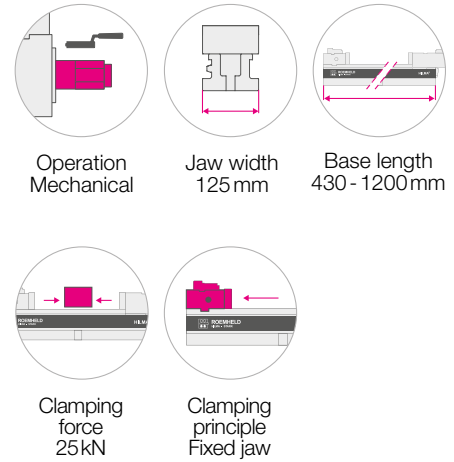

\* Tolerance ± 0.01 mm, \*\* Tolerance ± 0.02 mm  
All dimensions in mm

Z\_930730213\_10

Series		HILMA.NC 125.430	HILMA.NC 125.560	HILMA.NC 125.720	HILMA.NC 125.1000	HILMA.NC 125.1200
Operation		mechanical				
Base length L <sup>1)</sup>	[mm]	430	560	720	1000	1200
Clamping force	[kN]	40				
Clamping principle		against fixed jaw				
Clamping range S <sup>2)</sup>	[mm]	0–225	0–355	0–515	0–795	0–995
Clamping range S1 <sup>3)</sup>	[mm]	138–363	138–493	138–653	138–933	138–1133
Clamping range S2 <sup>3)</sup>	[mm]	206–431	206–561	206–721	206–1001	206–1201
Max total length L	[mm]	528	658	818	1098	1298
Partial length L1	[mm]	115	180	260	400	500
Retractable nipple bore hole	[mm]	25				
Retractable nipple bore holes	[pcs.]	2	3	3	4	5
Retractable nipple bore hole spacing	[mm]	200				
Retractable nipple bore hole for fixed jaw N	[mm]	15	-20	60	100	100
Weight with clamping jaws	[kg]	32.5	38.5	45.5	58.5	67.5
Part no.		930730203	930730303	930730403	930730803	930730903
Order no. with clamping force display L		930730213	930730313	930730413	930730813	930730913
Order no. with clamping force display R		930730214	930730314	930730414	930730814	930730914

<sup>1)</sup> Customised base versions and intermediate lengths possible ▶ more on page 22 & 23  
<sup>2)</sup> with standard clamping jaws (scope of supply)  
<sup>3)</sup> with top jaws ▶ more on page 32



**HILMA.NC 160**

The **HILMA.NC 160** is a mechanical/hydraulic machine vice with a jaw width of 160 mm.

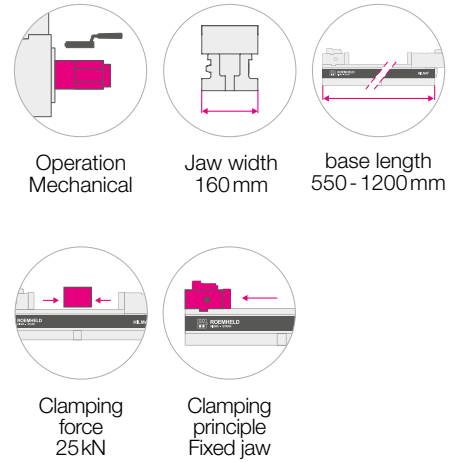
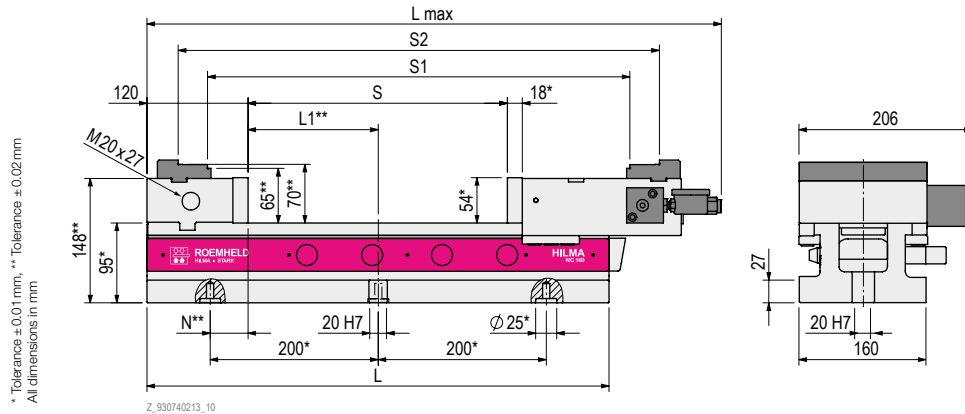

Figure: 930740203  
Standard scope of supply  
Machine vice incl. crank handle and clamping jaws



Series		HILMA.NC 160.550	HILMA.NC 160.750	HILMA.NC 160.1000	HILMA.NC 160.1200
Operation		mechanical			
Base length L <sup>1)</sup>	[mm]	550	750	1000	1200
Clamping force	[kN]	50			
Clamping principle		against fixed jaw			
Clamping range S <sup>2)</sup>	[mm]	0–308	0–508	0–758	0–958
Clamping range S <sup>1)</sup>	[mm]	194–502	194–702	194–952	194–1152
Clamping range S <sup>2)</sup>	[mm]	264–572	264–772	264–1022	264–1222
Max total length L	[mm]	684	884	1134	1334
Partial length L <sub>1</sub>	[mm]	155	255	380	480
Retractable nipple bore hole	[mm]	25			
Retractable nipple bore holes	[pcs.]	3	3	4	5
Retractable nipple bore hole spacing	[mm]	200			
Retractable nipple bore hole for fixed jaw N	[mm]	-45	55	80	80
Weight with clamping jaws	[kg]	59	71.5	87	99.5
Part no.		930740203	930740303	930740803	930740903
Order no. with clamping force display L		930740213	930740313	930740813	930740913
Order no. with clamping force display R		930740214	930740314	930740814	930740914

<sup>1)</sup> Customised base versions and intermediate lengths possible ▶ more on page 22 & 23  
<sup>2)</sup> with standard clamping jaws (scope of supply)  
<sup>3)</sup> with top jaws ▶ more on page 32

MACHINE VICE  
HYDRAULICALLY OPERATED, SINGLE-ACTING

# HILMA.NCH series

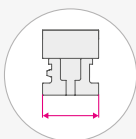

Jaw width

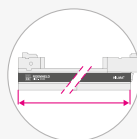

Base lengths\*

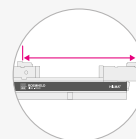

max.  
Jaw openings

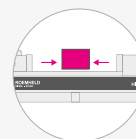

Clamping force

## HILMA.NCH 100



100mm

380mm  
540mm

390mm  
550mm

25 kN/350 bar

## HILMA.NCH 125



125mm

430mm  
560mm  
720mm  
1000mm  
1200mm

434mm  
564mm  
724mm  
1004mm  
1204mm

40 kN/350 bar

## HILMA.NCH 160



160mm

550mm  
750mm  
1000mm  
1200mm

577mm  
777mm  
1027mm  
1227mm

63 kN/350 bar

\* Customised base versions and intermediate lengths possible ▶ more on page 22 & 23

**HILMA.NCH 100**

The **HILMA.NCH 100** is a hydraulic, single-acting vice with a jaw width of 100mm.



Figure: 930820203  
Standard scope of supply  
Machine vice incl. crank handle and clamping jaws

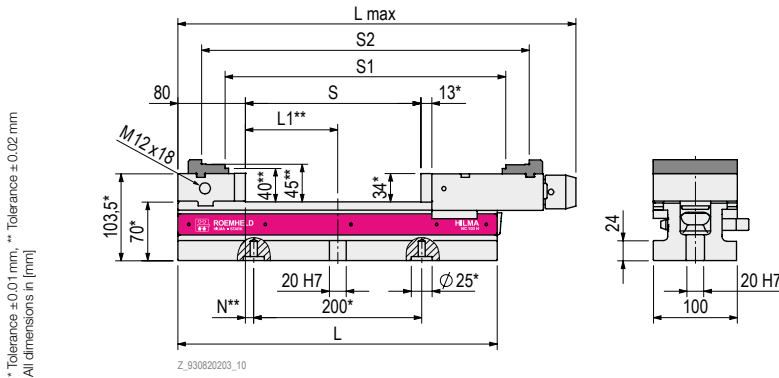
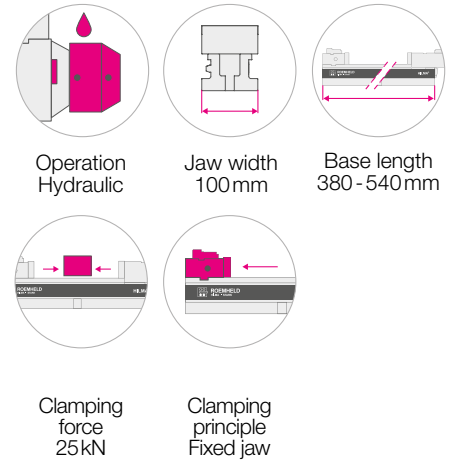

Series		HILMA.NCH 100.380	HILMA.NCH 100.540
Operation			hydraulic
Base length L <sup>1)</sup>	[mm]	380	540
Clamping force/operating pressure	[kN/bar]		25/350
Clamping principle			Fixed jaw
Clamping range S <sup>2)</sup>	[mm]	0–209	0–369
Clamping range S <sup>1 3)</sup>	[mm]	125–334	125–494
Clamping range S <sup>2 3)</sup>	[mm]	181–390	181–550
Clamping stroke	[mm]		5
Max total length L	[mm]	474	634
Partial length L <sub>1</sub>	[mm]	110	190
Retractable nipple bore hole	[mm]		25
Retractable nipple bore holes	[pcs.]	2	3
Retractable nipple bore hole spacing	[mm]		200
Retractable nipple bore hole for fixed jaw N	[mm]	10	-10
Weight with clamping jaws	[kg]	18.5	23.5
Part no.		930820203	930820303

<sup>1)</sup> Customised base versions and intermediate lengths possible ► more on page 22 & 23  
<sup>2)</sup> with standard clamping jaws (scope of supply)  
<sup>3)</sup> with top jaws ► more on page 32

**HILMA.NCH 125**

The **HILMA.NCH 125** is a hydraulic, single-acting vice with a jaw width of 125 mm.



Figure: 930830203  
Standard scope of supply  
Machine vice incl. crank handle and clamping jaws

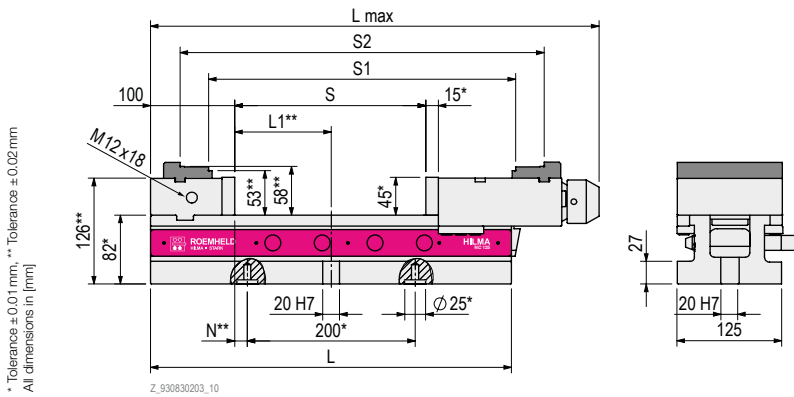
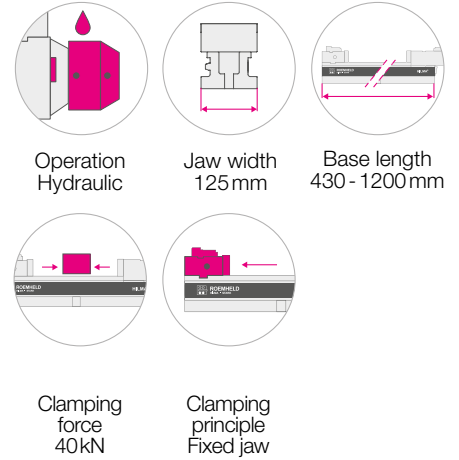

Series	HILMA.NCH 125.430	HILMA.NCH 125.560	HILMA.NCH 125.720	HILMA.NCH 125.1000	HILMA.NCH 125.1200	
Operation	hydraulic					
Base length L <sup>1)</sup>	[mm]	430	560	720	1000	1200
Clamping force/operating pressure	[kN/ bar]	40/350				
Clamping principle	Fixed jaw					
Clamping range S <sup>2)</sup>	[mm]	0–228	0–358	0–518	0–798	0–998
Clamping range S1 <sup>3)</sup>	[mm]	138–366	138–496	138–656	138–936	138–1016
Clamping range S2 <sup>3)</sup>	[mm]	206–434	206–564	206–724	206–1004	206–1204
Clamping stroke	[mm]	5				
Max total length L	[mm]	534	665	824	1104	1304
Partial length L1	[mm]	115	180	260		
Retractable nipple bore hole	[mm]	25				
Retractable nipple bore holes	[pcs.]	2	3	3	4	5
Retractable nipple bore hole spacing	[mm]	200				
Retractable nipple bore hole for fixed jaw N	[mm]	15	-20	60	100	100
Weight with clamping jaws	[kg]	32.5	38.5	45.5	58.5	67.5
Part no.		930830203	930830303	930830403	930830803	930830903

<sup>1)</sup> Customised base versions and intermediate lengths possible ▶ more on page 22 & 23  
<sup>2)</sup> with standard clamping jaws (scope of supply)  
<sup>3)</sup> with top jaws ▶ more on page 32

**HILMA.NCH 160**

The **HILMA.NCH 160** is a hydraulic, single-acting vice with a jaw width of 160 mm.



Figure: 930840203  
Standard scope of supply  
Machine vice incl. crank handle and clamping jaws

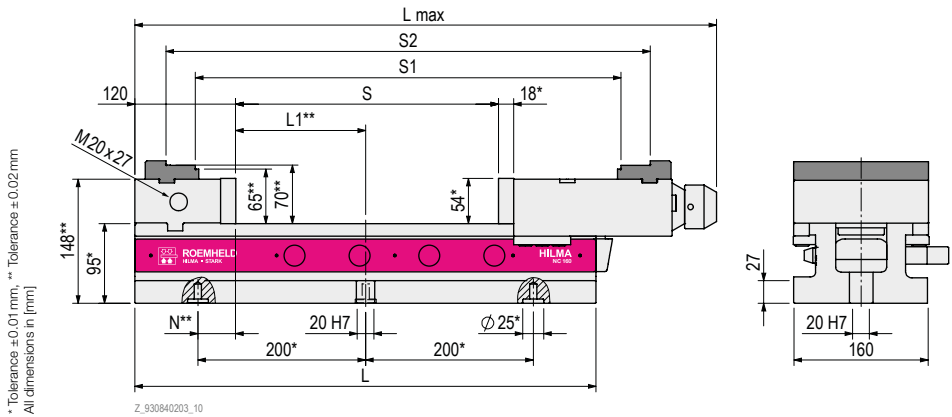
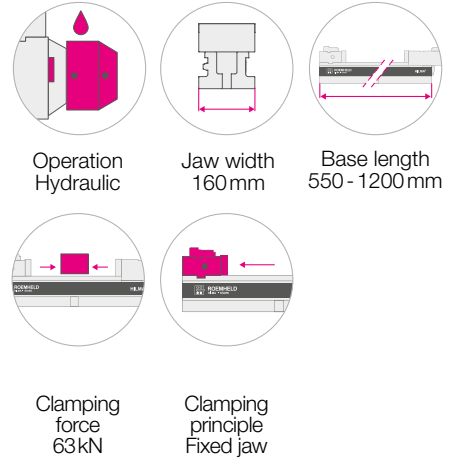

Series		HILMA.NCH 160.550	HILMA.NCH 160.750	HILMA.NCH 160.1000	HILMA.NCH 160.1200
Operation		hydraulic			
Base length L <sup>1)</sup>	[mm]	550	750	1000	1200
Clamping force/operating pressure	[kN/bar]	63/350			
Clamping principle		Fixed jaw			
Clamping range S <sup>2)</sup>	[mm]	0–313	0–513	0–763	0–963
Clamping range S <sup>1)</sup>	[mm]	194–507	194–707	194–1027	194–1157
Clamping range S <sup>2)</sup>	[mm]	264–577	264–777	264–1027	264–1227
Clamping stroke	[mm]	7			
Max total length L	[mm]	694	894	1144	1344
Partial length L <sup>1)</sup>	[mm]	155	255	380	480
Retractable nipple bore hole	[mm]	25			
Retractable nipple bore holes	[pcs.]	3	3	4	5
Retractable nipple bore hole spacing	[mm]	200			
Retractable nipple bore hole for fixed jaw N	[mm]	-45	55	80	80
Weight with clamping jaws	[kg]	59	71.5	87	99.5
Part no.		930840203	930840303	930840803	930840903

<sup>1)</sup> Customised base versions and intermediate lengths possible ▶ more on page 22 & 23  
<sup>2)</sup> with standard clamping jaws (scope of supply)  
<sup>3)</sup> with top jaws ▶ more on page 32

STANDARDISED ADDITIONAL OPTIONS

# Flat rate reworking

The standard base of the **HILMA.NC** series can be adapted to specific machine requirements through various rework operations. The standardised additional options are offered at an attractive flat rate price.



## Supplementary order numbers

- For standardised reworking
- slot for adjustable fixed jaw
  - Additional crosswise keyway
  - Threaded fastening holes

The supplementary order numbers according to the table apply to the **HILMA.NC**. Feasibility and implementation can be clarified in consultation.

<b>HILMA.NC 100</b> <b>HILMA.NCH 100</b>	<b>HILMA.NC 125</b> <b>HILMA.NCH 125</b>	<b>HILMA.NC 160</b> <b>HILMA.NCH 160</b>
930PNA100*	930PNA125*	930PNA160*

\* The supplementary order number stands for all rework. Details on implementation and feasibility on request.

### Additional slot for displaceable fixed jaw

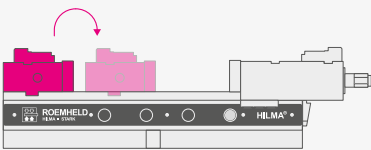

Optionally, the fixed jaw can be adjusted by means of an additional slot in the slide guide surface. The adjustable fixed jaw enables operator-friendly set-up for workpieces of different sizes. Recommended for ergonomic operation with large base lengths and smaller clamping ranges.

### Additional crosswise keyway for Positioning



An additional crosswise keyway is used for optimum positioning on the machine table. The position of the additional crosswise keyway can be freely selected after consultation and verification of feasibility.

### Additional threaded fastening holes & retractable nipple bore holes

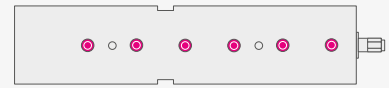

Customised threaded fastening holes and positioning bore holes in the base of the vice at the factory according to parameter specifications or as reworking are possible

BASE OF VICE ACCORDING TO CUSTOMER REQUIREMENTS

# Customised designs

In addition to the standard versions of the modular **HILMA.NC** series, customised base versions can be realised. This means that the machine vice can be manufactured to fit precisely for individual travel paths, working spaces, clamping surfaces and machining tasks. Possible options and designs include:

- Freely selectable intermediate lengths
- Segment design  
Fixed jaws - & clamping segment
- Multiple clamps
- Larger heights
- Own spacing for retractable nipple

## Freely selectable base intermediate lengths

In addition to the standard lengths, customised intermediate lengths can be ordered. The length of the base of the vice can be designed as desired up to the largest standard length of the respective jaw width.

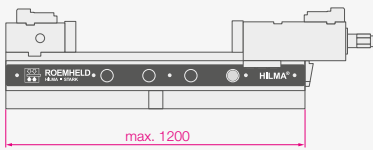

	<b>HILMA.NC 100</b> <b>HILMA.NCH 100</b>	<b>HILMA.NC 125</b> <b>HILMA.NCH 125</b>	<b>HILMA.NC 160</b> <b>HILMA.NCH 160</b>
<b>Optional intermediate lengths (max)*</b>	to 540 mm	to 1200 mm	up to 1200 mm
<b>Standard Base lengths</b>	380 mm 540 mm	430 mm 560 mm 720 mm 1000 mm 1200 mm	550 mm 750 mm 1000 mm 1200 mm

\* Details on implementation and feasibility on request.

## Further examples of vice designs

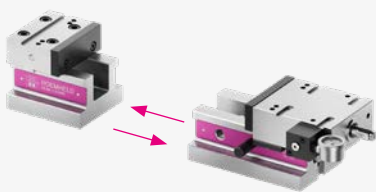

### Segmental design

The segments can be placed anywhere on the machine table and are mainly used on large machining centres. Large working spaces can be optimally used with standard clamping systems and complex devices for workpiece clamping are no longer required.

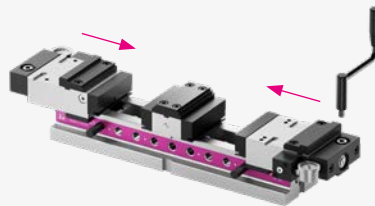

### Multiple clamps

Flexible dual clamping systems enable the efficient double machining of workpieces with the same or different dimensions. Both clamping locations work independently of each other.

THE OPTIMUM JAW FOR EVERY WORKPIECE

# Extensive range of jaws

High clamping quality



High clamping safety

The jaws used have a major influence on the machining result. The extensive range of jaws enables reliable blank and finished part clamping in all shapes from round to square and from small to large. All jaws are hardened on the reference surfaces and ground with high precision (except soft clamping jaw).

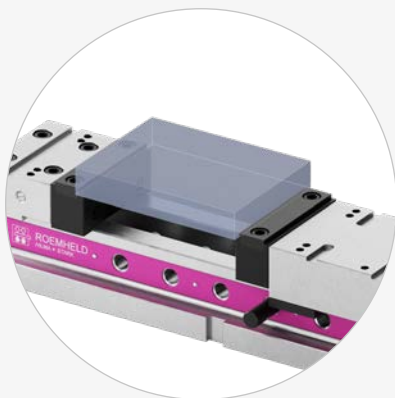

## Blanks

Jaws with interchangeable insert  
Page 29



## Blanks

Claw jaws with fine grade  
Page 27



## Blanks

Top jaw segments  
Page 33

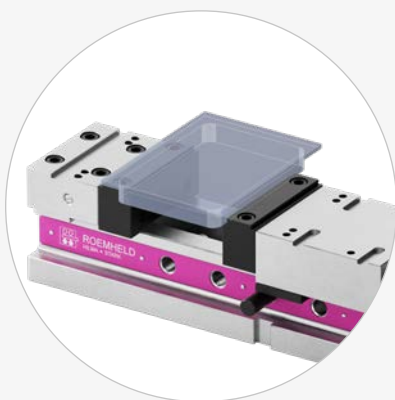

## Finished parts, second side

Jaws with interchangeable insert  
Page 29

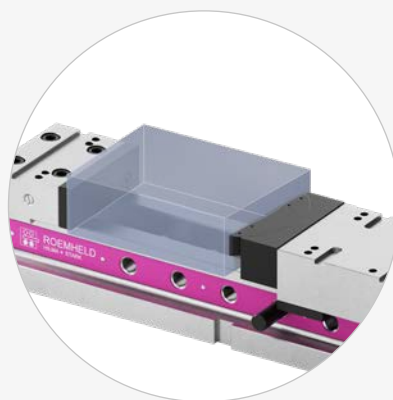

## Compensation of angular errors

pendulum jaws  
Page 28



## Round blanks

Top jaw segments  
Page 33



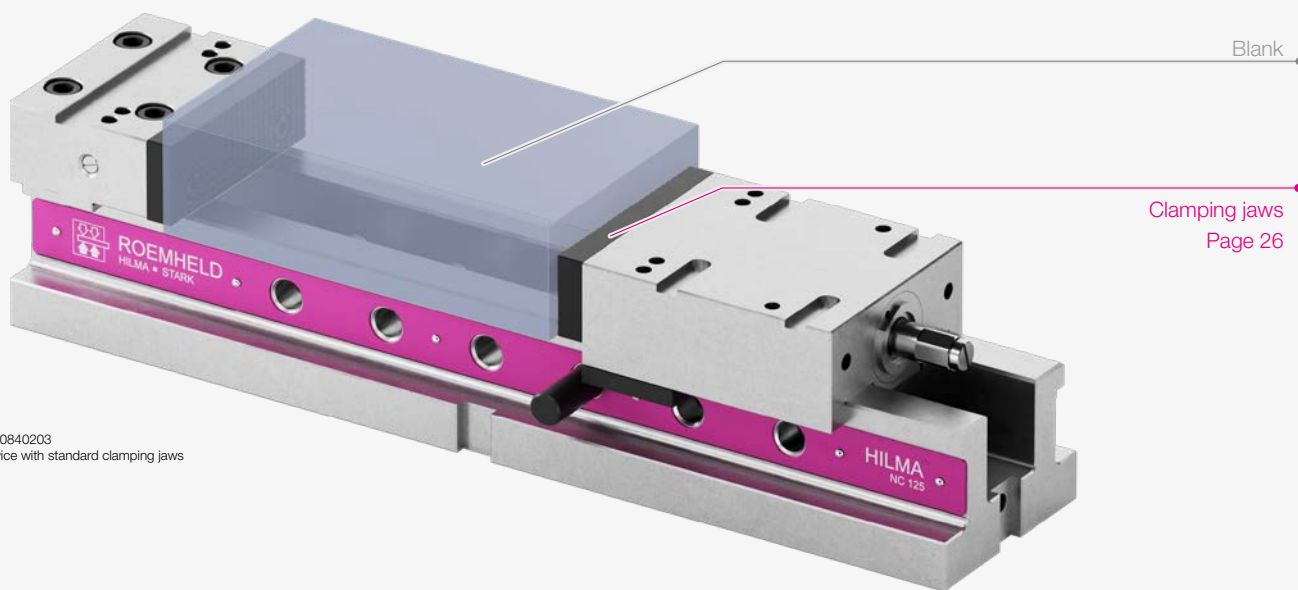

Figure: 930840203  
Machine vice with standard clamping jaws



**Narrow parts**  
SlimFlex - with step inserts  
Page 31



**Large parts**  
Top jaws  
Page 32



**Flexible production for finished parts**  
PinFlex clamping jaws for steps and angles  
Page 30



**Cylindrical parts - vertical**  
Vee jaws  
Page 28



**Cylindrical parts - horizontal**  
Vee jaws  
Page 28



**Jaw change without tools**  
QIS quick-change jaws  
Page 34

## Clamping jaws

The clamping jaws of the **HILMA.NC** machine vices are designed as exchangeable clamping bars. Using clamping jaws or jaw inserts with coating or grip serrated, the retention forces for safe clamping of workpieces can be considerably increased.

- The **HILMA.NC** and **HILMA.NCH** series are delivered with smooth/serrated clamping jaws.
- ▶ When using inserts or clamping jaws with a coating or grip serration, controlled clamping is only possible in conjunction with a clamping force display.

**INFO**

Length & clamping range

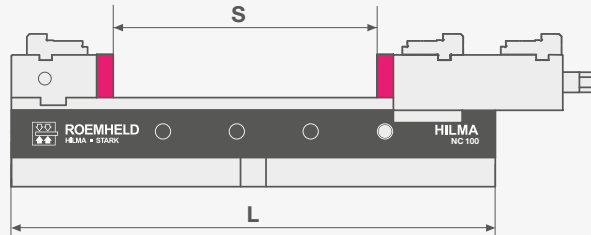

### Smooth/serrated clamping jaws

Standard reversible clamping jaw with one side ground smooth for clamping finished parts and one side serrated for clamping blanks. **HILMA.NC** and **HILMA.NCH** are included in the standard scope of supply.

Scope of supply: Set with 2 clamping jaws and 4 fixing screws

Type	Part no.	Dimensions			Base length L	Clamping range S
		b	c	h		
NC 100	932711201	100	13	34	380	0-205
					540	0-365
NC 125	932711301	125	15	45	430	0-225
					560	0-355
					720	0-515
					1000	0-795
NC 160	932711401	160	18	54	1200	0-995
					550	0-308
					750	0-508
					1000	0-758
					1200	0-958

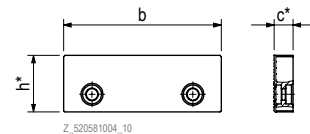
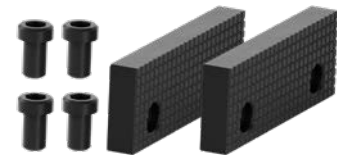

\* Tolerance ±0.01 mm  
All dimensions in [mm]  
fastening material included in scope of supply

### Clamping jaws extra large, serrated, hardened and ground

For clamping workpieces that exceed the normal jaw width.

Used in pairs only.

Scope of supply: Set with 2 clamping jaws and 4 fixing screws

Type	Part no.	Dimensions				Base length L	Clamping range S
		b	b1	c	h		
NC 100	932721201	100	125	13	34	380	0-205
						540	0-365
NC 125	932721301	125	160	15	45	430	0-225
						560	0-355
						720	0-515
						1000	0-795
NC 160	932721401	160	200	20	54	1200	0-995
						550	0-304
						750	0-504
						1000	0-754
						1200	0-954

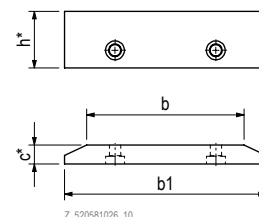
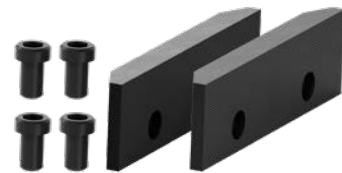

\* Tolerance ±0.01 mm  
All dimensions in [mm]  
fastening material included in scope of supply

### Clamping jaws, soft

Soft jaw for quick insertion of workpiece-specific clamping or contact points as well as contours. Used in pairs only.

Scope of supply: Set with 2 clamping jaws and 4 fixing screws

Type	Part no.	Dimensions			Base length L	Clamping range S
		b	c	h		
NC100	932731201	100	20	36	380	0–191
					540	0–351
NC125	932731301	125	25	47	430	0–205
					560	0–335
					720	0–495
					1000	0–775
NC160	932731401	160	30	56	1200	0–975
					550	0–284
					750	0–484
					1000	0–734
					1200	0–934

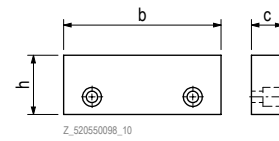
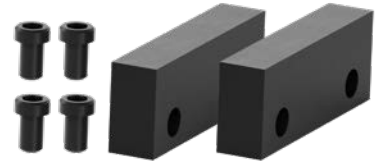

Z\_520550098\_10

All dimensions in [mm]  
fastening material included in scope of supply

### Claw jaws with fine grade

For blank clamping. A clamping depth of 2.5 mm (pull-down effect) results in little material loss on the workpiece. 5 sides can be machined in a single clamping operation without pre-stamping. A clamping force display is recommended. Used in pairs only.

Scope of supply: Set with 2 claw jaws and 4 fixing screws

Type	Part no.	Dimensions					Base length L	Clamping range	Clamping depth	Support
		a	b	c	d	e				
NC100	932871201	100	11	34	65	6.6/11	380	4–215	2.5	2.0
							540	4–375		
NC125	932871301	125	14	45	80	8.5/15	430	4–239	2.5	2.0
							560	4–369		
							720	4–529		
							1000	4–809		
NC160	932871401	160	17	54	100	10.5/18	1200	4–1009	2.5	2.0
							550	4–328		
							750	4–528		
							1000	4–778		
						1200	4–978			

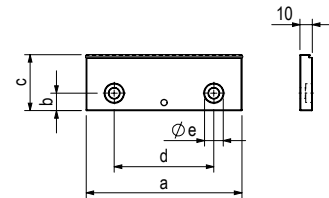

Z\_520900002\_10

All dimensions in [mm]  
fastening material included in scope of supply

### Hardened and ground precision step jaws

Preferably used for clamping pre-machined workpieces for precision manufacturing (parallelism accuracy). Used in pairs only.

Scope of supply: Set with 2 precision step jaws and 4 fixing screws

Type	Part no.	Dimensions							Base length L	Clamping range	
		b	c	c1	c2	h	h1	h2		Step h1	Step h2
NC100	932741201	100	19	15	11	35	10	29	380	8–201	16–209
									540	8–361	16–369
NC125	932741301	125	25	20	16	45	13	39	430	10–215	18–223
									560	10–345	18–353
									720	10–505	18–513
									1000	10–785	18–793
NC160	932741401	160	25	20	16	54	15	45	1200	10–985	18–993
									550	10–304	18–312
									750	10–504	18–512
									1000	10–754	18–762
								1200	10–954	18–962	

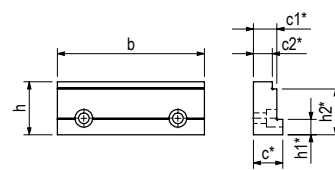

Z\_520820002\_10

\* Tolerance ±0.01 mm  
All dimensions in [mm]  
Fastening material included in scope of supply

### Hardened and ground vee jaw

For horizontal and vertical clamping of round workpieces.  
Scope of supply: Set with 1 vee jaw and 2 fixing screws

Type	Part no.	Dimensions				Clamping diameter d
		b	c	h	h1	
NC100	932751201	100	17	34	19	8–35
NC125	932751301	125	19	45	27	10–50
NC160	932751401	160	21	54	32	12–60

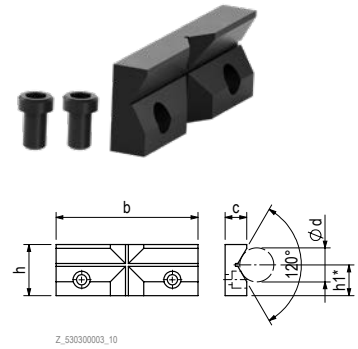

\* Tolerance ±0.01 mm, all dimensions in [mm]  
fastening material included in scope of supply

### Hardened and ground pendulum jaw with grip inserts

Pendulum jaws are used to compensate angular errors on the workpiece (max. swivel range 5°). They enable the safe clamping of sawn sections, for example, in a simple way. Use only on the clamping slide.  
Scope of supply: Set with 1 pendulum jaw and 2 fixing screws

Type	Part no.	Dimensions				Base length L	Clamping range S
		b	c	h	h1		
NC100	on request	100	35	34	16	380	0–183
						540	0–343
						430	0–190
NC125	937118011	125	50	45	22	560	0–320
						720	0–480
						1000	0–760
						1200	0–960
NC160	937118014	160	55	54	26	550	0–271
						750	0–471
						1000	0–721
						1200	0–921

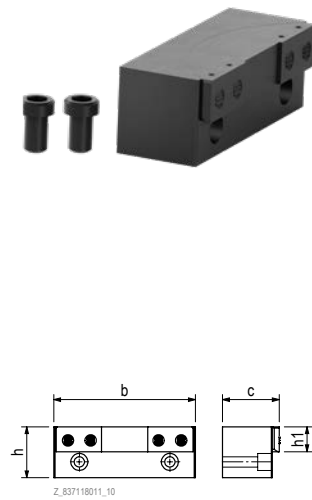

All dimensions in [mm]  
fastening material included in scope of supply

### INFO

#### Jaws with interchangeable insert

The clamping jaws can be used universally due to the interchangeable inserts. They can be used for clamping finished parts as well as blank clamping, even with round shapes.



### Clamping jaws with grip/smooth interchangeable insert, hardened and ground

The clamping jaws can be used for blank and finished part clamping due to the interchangeable insert. If the grip texture is worn, only the interchangeable insert needs to be replaced. Used in pairs only. Optional clamping force display recommended.

Scope of supply: Set with 2 clamping jaws incl. interchangeable inserts & 8 fixing screws

Type	Part no.	b	b1 <sup>H7</sup>	c	c1	h	h1	h2	Base length L	Clamping range S
NC 100	932861201	100	78	34	22	37	34	4	380	9-172
									540	9-332
									430	9-184
									560	9-314
NC 125	932861301	125	98	40	28	48	45	4	720	9-474
									1000	9-754
									1200	9-954
									550	9-261
NC 160	932861401	160	125	46	34	57	54	6	750	9-461
									1000	9-711
									1200	9-911

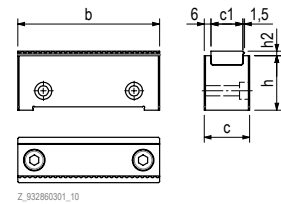

Z\_932861001\_10

All dimensions in [mm]  
fastening material included in scope of supply

### Grip/smooth interchangeable insert, hardened and ground

Scope of supply: Set with 1 interchangeable insert and 2 fixing screws

Type	Part no.	Dimensions			Base length L	Clamping range S
		b	c	h		
NC 100	932862201	100	22	10	380	12-175
					540	12-335
					430	12-187
					560	12-317
NC 125	932862301	125	28	12	720	12-477
					1000	12-757
					1200	12-957
					550	12-264
NC 160	932862401	160	34	16	750	12-464
					1000	12-714
					1200	12-914

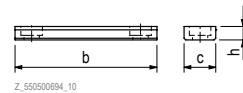
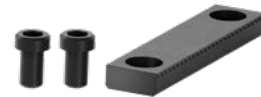

Z\_550500694\_10

All dimensions in [mm]  
fastening material included in scope of supply

### Round, grip interchangeable insert, hardened and ground

The round interchangeable inserts are used for blank clamping. For example, they allow three-point clamping as well as the clamping of round workpieces. Optional clamping force display recommended.

Scope of supply: Set with 1 interchangeable insert and 1 fixing screw

Type	Part no.	Dimensions					Base length L	Clamping range Ø	
		b	c	c1	Ød	h			h2
NC 100	932863201	100	34	22	27	10	4	380	40-185
								540	40-345
								430	52-202
								560	52-332
NC 125	932863301	125	40	28	33	12	4	720	52-492
								1000	52-772
								1200	52-972
								550	60-280
NC 160	932863401	160	46	34	39	14	4	750	60-480
								1000	60-730
								1200	60-930

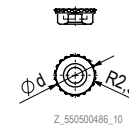

Z\_550500486\_10

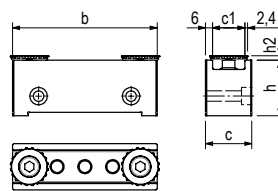

Z\_000000000\_10

All dimensions in [mm]  
Fastening material included in scope of supply

## PinFlex clamping jaws

### + Flexible without end

The use of PinFlex clamping jaws allows fast and precise alignment of workpieces. This is supported by horizontal and vertical scaling.

- Workpiece support steps
- Clamping depths
- Angle, contours
- Workpiece stop

Dropping workpiece supports and disturbing workpiece stops are no longer required.

#### Function:

The pins are extended in rows with the aid of compressed air (e.g. compressed air gun) and pushed back individually depending on the application.

### INFO

### PinFlex applications

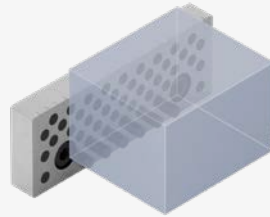

Depth clamping

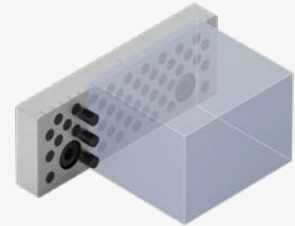

Workpiece stop

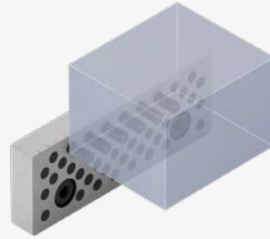

Height clamping

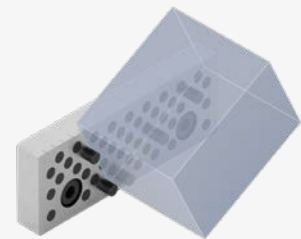

angle bracket

## Hardened and ground PinFlex clamping jaw

Scope of supply: Set with 1 PinFlex clamping jaw (compressed air, left or right) and 2 fixing screws

Type	Order no. left	Order no. right	Dimensions			Base length L	Clamping range S
			b	c	h		
NC 100	938282670	938282691	100	13	34	380	0-205
						540	0-365
						430	0-225
						560	0-355
NC 125	938282660	938282682	125	15	45	720	0-515
						1000	0-795
						1200	0-995
						550	0-308
NC 160	938282680	938282701	160	18	54	750	0-508
						1000	0-758
						1200	0-958

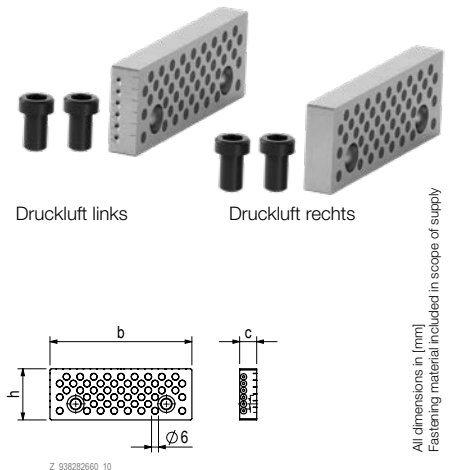

All dimensions in [mm]  
Fastening material included in scope of supply

## SlimFlex jaw system

### + sma clamped

Optimised 3-sided machining of workpieces in one clamping operation

The SlimFlex jaw system allows 3-sided machining of centrally clamped workpieces that are dimensionally below the jaw width of the clamping device. Due to the step inserts, the workpiece is free to move against the base jaws and thus make it optimally accessible for the work spindle from 3 sides.

- No asymmetrical loading of the workpiece
- Simple adjustment of different jaw widths

### INFO

### SlimFlex operation



1. The blank is approx. 2mm above the finished dimension

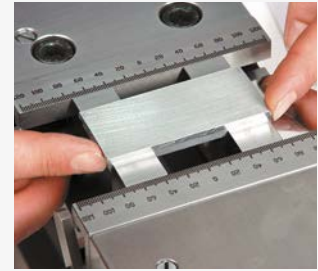

3. Insert workpiece blank centrally by sight and clamp



2. Set the outer edges of the inserts approx. 2mm below the finished dimension.

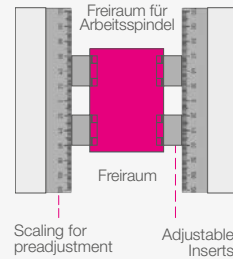

## SlimFlex jaw system

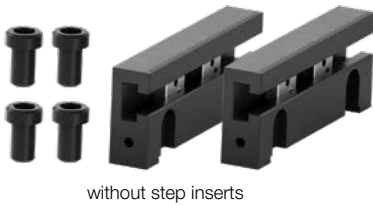

without step inserts

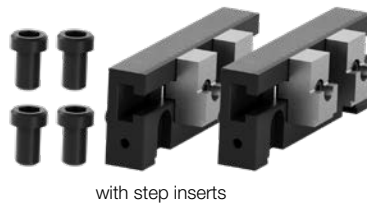

with step inserts

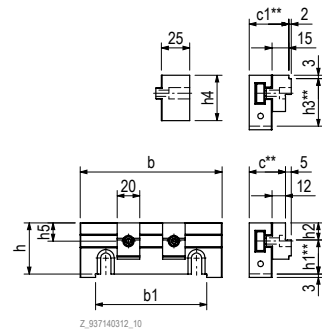

Used in pairs only. Scope of supply: Set with 2 SlimFlex jaws and 4 fixing screws with or without step inserts

\* Tolerance ±0.01 mm; \*\* Tolerance ±0.02 mm  
All dimensions in [mm]  
Fastening material included in scope of supply

Type	Order no. without step inserts	Order no. with step inserts	Part no. Insert C45 soft	Dimensions										Base length L	Clamping range S
				b	b1 <sup>H7</sup>	c	c1	h	h1	h2	h3	h4	h5		
NC 100	937141201	937142201	550500123	100	78	30	33	34	24	10	31	30	11	380	4-165 / 10-171
														540	4-325 / 10-331
														430	4-185 / 10-191
NC 125	937141301	937142301	550500099	125	98	32	35	45	30	15	42	40	16	560	4-315 / 10-321
														720	4-475 / 10-481
														1000	4-725 / 10-761
														1200	4-925 / 10-961
NC 160	937141401	937142401	550500099	160	125	34	37	54	39	15	51	40	16	550	4-271 / 10-277
														750	4-471 / 10-477
														1000	4-721 / 10-727
														1200	4-921 / 10-927

## Top jaws

Top jaws are used for clamping large workpieces.

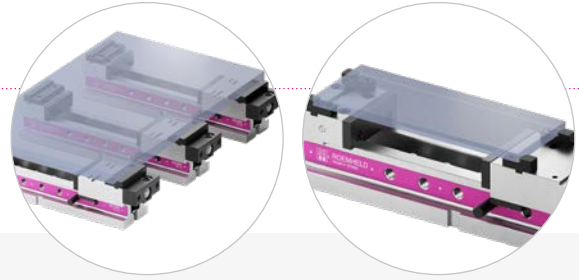

### INFO

#### Length & clamping ranges

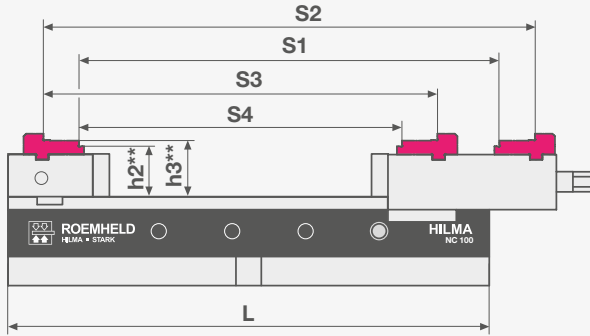

- S1: Clamping range for lower step of top jaw
- S2: Clamping range for upper step of top jaw
- S3: Clamping range for lower step of top jaw
- S4: Clamping range for upper step of top jaw
- h2: Distance dimension between guideway and lower step of top jaw
- h3: Distance dimension between guideway and upper step of top jaw

## Hardened and ground top jaws

Top jaws are a simple and effective way to extend the jaw opening. They are used in pairs on slides and fixed jaws. Used for clamping pre-machined or finished workpieces. Used in pairs only. Scope of supply: Set with 2 top jaws and 4 fixing screws

Type	Part no.	Dimensions			Base length L	Clamping range			
		b	c	h		S4	S3	S1	S2
NC 100	932843201	100	47.8	16.5	380	48–252	76–280	125–329	181–385
					540	48–412	76–440	125–489	181–545
					430	62–287	130–355	138–363	206–431
NC 125	932843301	125	57.8	19.0	560	62–417	130–485	138–493	206–561
					720	62–577	130–645	138–653	206–721
					1000	62–857	130–925	138–933	206–1001
NC 160	932843401	160	63.8	22.0	1200	62–1057	130–1125	138–1133	206–1201
					550	96–404	166–474	194–502	264–572
					750	96–604	166–674	194–702	264–772
NC 160	932843401	160	63.8	22.0	1000	96–854	166–924	194–952	264–1022
					1200	96–1054	166–1124	194–1152	264–1222

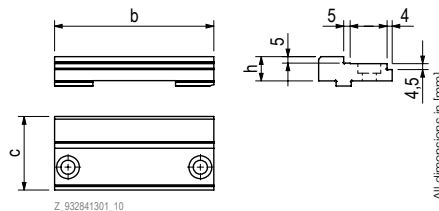

All dimensions in [mm]  
Fastening material included in scope of supply

▶ Top jaws for vices before 2023 available on request

### INFO

#### New bore holes for top jaws

The top jaws listed above are suitable for the reworked fixed jaw. Recognisable from the new borehole pattern (see figure). Reworking of older vices by the customer is possible after consultation.





### Grip top jaw segment, hardened and ground

Top jaw segments are used for clamping round blanks, for example. A clamping force display is recommended. They are used in pairs on slides and fixed jaws. Scope of supply: Set with 4 segments and 4 fixing screws



Type	Part no.	Dimensions					Base length L	Clamping range	
		b	c	c1	c2	h		S1	S2
NC 100	932851201	15	40	4	17	11.5	380	102–306	179–383
							540	102–466	179–543
							430	124–349	200–425
							560	124–479	200–555
NC 125	932851301	19	50	3	23	14	720	124–639	200–715
							1000	124–919	200–995
							1200	124–1119	200–1195
							550	171–479	269–577
NC 160	932851401	28	60	6	22	17	750	171–679	269–777
							1000	171–929	269–1027
							1200	171–1129	269–1227

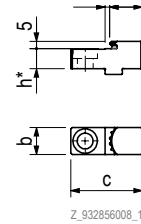

Z\_932856008\_10

\* Tolerance ±0.01 mm  
All dimensions in [mm]  
Fastening material included in scope of supply

**INFO**

### Top jaw segments

Top jaw segments are used with 2 each on the slide and fixed jaw.

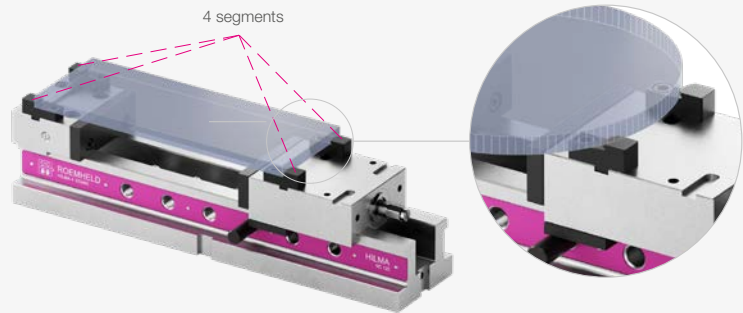

## QIS quick-change jaws

### + Set-up in record time

Jaw change in seconds with magnetic QIS jaws (Quick Insert System).

The base jaws of the QIS system are equipped with permanent magnets and are screwed to the fixed jaw or slide.

The QIS interchangeable jaws can be easily and quickly attached to the QIS base jaws without tools.



### INFO

#### Operating principle of the quick-change jaws



Mount the magnetic base jaw

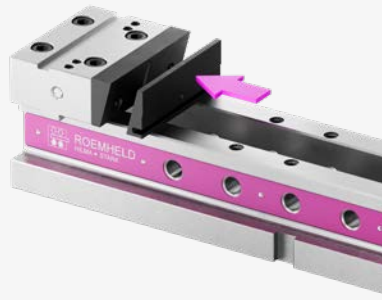

Introduce QIS interchangeable jaw in parallel & guide alignment pin

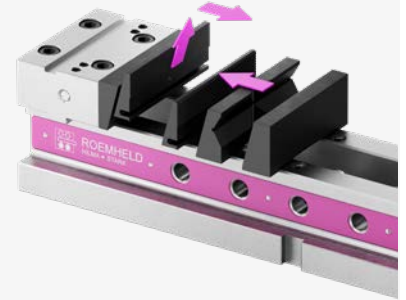

Push the QIS interchangeable jaw up to the end of the slot and tilt

### Ground QIS base jaws with permanent magnets

Used in pairs only.

Scope of supply: Set with 2 base jaws and 4 fixing screws

Type	Part no.	Dimensions		
		b	c	h
NC100	937710213	100	16	34
NC125	937710313	125	20	45
NC160	937710413	160	23	54

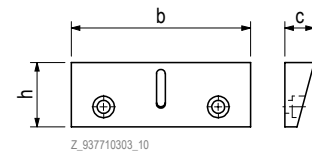

Z\_937710303\_10

All dimensions in [mm]  
Fastening material included in scope of supply

### Hardened and ground QIS interchangeable jaw with steps

Used in pairs only.

Scope of supply: 1 interchangeable jaw

Type	Part no.	Dimensions						Base length L	Clamping range		
		b	c	c1	c2	h	h1		h2	Step h1	Step h2
NC100	837714201	100	21	4	25	34	10	29	380	8-181	16-189
									540	8-341	16-349
									430	10-195	18-203
NC125	837714301	125	26	5	30	45	13	39	560	10-325	18-333
									720	10-485	18-493
									1000	10-765	18-773
NC160	837714401	160	31	5	35	54	15	45	550	10-274	18-282
									750	10-474	18-482
									1000	10-724	18-732
									1200	10-924	18-932

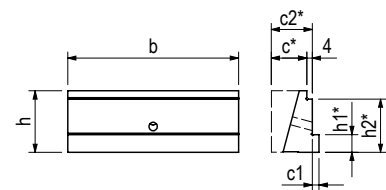

Z\_837714301\_10

\* Tolerance ±0.01 mm  
All dimensions in [mm]

### Smooth or serrated QIS interchangeable jaw, hardened and ground

For clamping finished parts (smooth) and for clamping blanks (serrated).  
Scope of supply: 1 interchangeable jaw

Type	Part no. smooth	Part no. Serrated	Dimensions			Base length L	Clamping range S
			b	c	h		
NC100	837711201	837712201	100	21	34	380	0-189
						540	0-349
						430	0-203
NC125	837711301	837712301	125	26	45	560	0-333
						720	0-493
						1000	0-773
						1200	0-973
NC160	837711401	837712401	160	31	54	550	0-282
						750	0-482
						1000	0-732
						1200	0-932

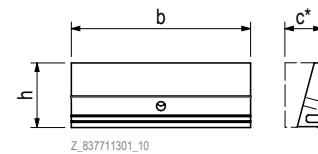
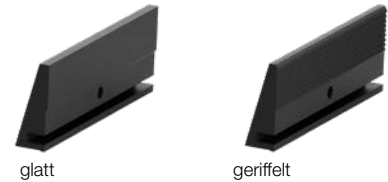

Z\_837711301\_10

\* Tolerance ±0.01 mm  
All dimensions in [mm]

### Hardened and ground QIS interchangeable jaw with prisms

For horizontal and vertical clamping of round workpieces.  
Scope of supply: 1 interchangeable jaw

Type	Part no.	Dimensions						Clamping diameter d
		b	b1 <sup>H7</sup>	c	c1	h	h1	
NC100	837715201	100	78	53	28.0	34	19	8-35
NC125	837715301	125	98	58	34.2	45	27	10-50
NC160	837715401	160	125	60	37.0	54	32	12-60

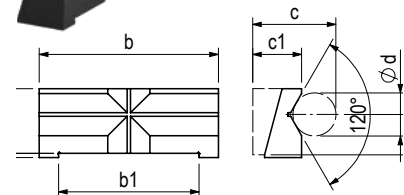
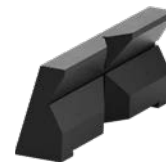

Z\_837715301\_10

\* Tolerance ±0.01 mm  
All dimensions in [mm]

### QIS interchangeable jaw, soft

Soft jaw for quick insertion of workpiece-specific clamping or contact points as well as contours.  
Scope of supply: 1 interchangeable jaw

Type	Part no.	Dimensions				Base length L	Clamping range S
		b	b1 <sup>H7</sup>	c	h		
NC100	837717201	100	78	30.0	34	380	0-171
						540	0-331
						430	0-182
NC125	837717301	125	98	36.5	45	560	0-312
						720	0-472
						1000	0-752
						1200	0-952
NC160	837717401	160	125	47.0	54	550	0-250
						750	0-450
						1000	0-700
						1200	0-900

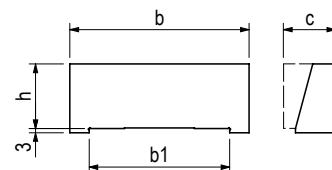

Z\_837717301\_10

All dimensions in [mm]

OPTIONS FOR FIXAXTION ON THE MACHINE TABLE

# Mounting versions

Stable fixation on the machine table is of great importance to ensure precise machining. Depending on the type of machining and the

individual requirements, one of the fixation options shown below can be selected.

- ▶ Screw connection
- ▶ Clamping device such as clamping claws
- ▶ Zero point clamping system



## Retractable nipple for ZPC

Thanks to the integrated retractable nipple bore holes in the base of the vice, HILMA machine vices can be perfectly supplemented and combined with STARK zero point clamping systems.

A zero point clamping system consists of a fast closing clamp in which the retractable nipples are clamped. In order to compensate for

manufacturing tolerances and the necessary "mobility for thermal expansion" on a pallet "temperature variation", three different retractable nipples are combined.

- ⊕ Retractable nipple with zero point (NP)
- ⊖ Retractable nipple with equaliser (AG)
- Retractable nipple without centring (OZ)

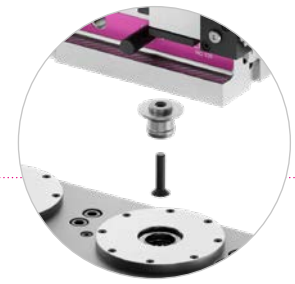

### Retractable nipple for FCP STARK.classic.2



### Retractable nipple for FCP STARK.basic.M



Part no.	Draw-in nipple
S804-470	with zero point STARK.classic.2 NP
S804-471	with compensation STARK.classic.2 AG
S804-472	without centring STARK.classic.2 OZ

Part no.	Draw-in nipple
S8000-300	with zero point STARK.basic.M NP
S8000-301	with compensation STARK.basic.M AG
S8000-302	without centring STARK.basic.M OZ

### INFO

### Symbols

- ⊕ **with zero point (NP)**  
without equaliser direction
- ⊖ **with equaliser (AG)**  
Compensation of theoretical centre in equaliser direction
- **without centring (OZ)**  
Compensation of theoretical centre in all directions

### INFO

### Compensation principle

Depending on the requirement of the clamping situation, there are many options to compensate for tolerances in different materials and fixture sizes with the aid of retractable nipples. The combination of retractable nipples depends on the number of these on the machine vice.

Assignment examples:

- 2 × retractable nipples  
**NP - AG**
- 3 × retractable nipples  
**NP - OZ - AG**
- 4 × retractable nipples  
**NP - OZ - OZ - AG**





## Fast closing plate for ZPC

STARK standard fast closing plates (FCP) are a cost-effective entry-level solution for high-quality zero point clamping systems (ZPC) and provide a secure and versatile connection between the machine vice and machine table.

- Fast closing plate made of steel ground on both sides with threaded fastening holes for different slot spacings
- Zero point clamping system is clamped mechanically with spring force and released hydraulically/pneumatically
- Area of application on 3/4/5-axis machines for all common machining procedures such as milling, grinding, eroding

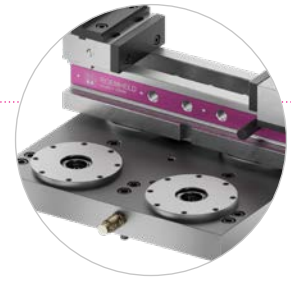

### STARK.classic standard fast closing plate

- Hydraulic release system
- up to 120kN active insertion force

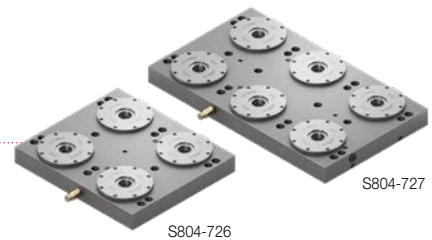

Part no.	Quick-locking plate	Size	Gauge for bore holes
S804-726	Fast closing plate with 4 STARK.classic.2 (S804-452)	4x 396 × 346 × 46 mm	200 × 200 mm
S804-727	Fast closing plate with 6 STARK.classic.2 (S804-452)	6x 596 × 346 × 46 mm	200 × 200 mm

### STARK.basic standard fast closing plate

- Pneumatic release system
- up to 54 kN retention force



Part no.	Quick-locking plate	Size	Gauge for bore holes
S804-307	Fast closing plate with 4 STARK.basic.M (S805-202)	4x 396 × 346 × 46 mm	200 × 200 mm
S805-308	Fast closing plate with 6 STARK.basic.M (S805-202)	6x 596 × 346 × 46 mm	200 × 200 mm

## Clamping claws & keyblocks

### clamping claws

For safe clamping on the machine table.  
Scope of supply: 4 clamping claws incl.  
4 fixing screws

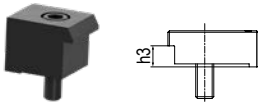

Part no.	Thread	h3 [mm]
937772011	M12	24
937773011	M12	27
937773021	M16	27

### Nuts for T-slots, DIN 508

T-keyblock nuts are simply pushed in sideways to clamp the vice on the machine table.  
Scope of supply: 4 keyblocks

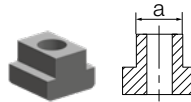

Part no.	Thread	Width a
937773211	M12	14
937773231	M12	18
937773311	M16	18

### Keyblocks, loose, DIN 6323

Loose keyblocks for precise alignment of the vice on the machine table in the longitudinal or crosswise keyway 20 H7.  
Scope of supply: 2x keyblocks, loose



Part no.	Table slot a
939174121	14 h6
939174141	18 h6

ERGONOMIC AND SAFE OPERATON

# Accessories for **HILMA.NC** series

## Crank handle for **HILMA.NC**

for mechanical/hydraulic design



Type	Part no.	SW
NC 100	420560020	14
NC 125	420560019	17
NC 160	420560021	19

## Crank handle for angle drive

Crank handle for angle drive (only **HILMA.NC** series). Crank handle is in scope of supply Angle drive included.



Part no.	Part no.
Crank	420560031

## Crank handle for **HILMA.NCH**

for hydraulic design



Type	Part no.	SW
NCH 100	420560022	8
NCH 125	420560022	8
NCH 160	420560023	10

## Crank handle extension for **HILMA.NC**

for mechanical/hydraulic design



Type	Part no.	SW	Extension* [mm]
NC 100.540	520570021	14	154
NC 125.560	520570028	17	121
NC 125.720	520570022	17	268
NC 160.750	520570023	19	178

\* actual extension after attachment

## Angle drive with crank handle for **HILMA.NC**

for mechanical/hydraulic design.

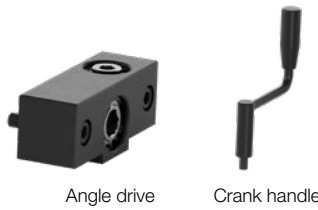

Type	Part no.	SW	b	Crank radius
NC 100	932940505	10	39	125
NC 125	932940605	10	43	125
NC 160	932940705	10	46	125

## Crank handle extension for **HILMA.NCH**

for hydraulic design



Type	Part no.	SW	Extension* [mm]
NCH 100.540	520570024	8	156
NCH 125.560	520570027	8	141
NCH 125.720	520570025	8	301
NCH 160.750	520570026	10	224

\* actual extension after attachment

## Precision workpiece stop

can be swivelled away, with fast clamping and adjustment in 2 planes



Type	Part no.	Thread
NC 100	932910201	M12
NC 125		
NC 160	932910401	M20

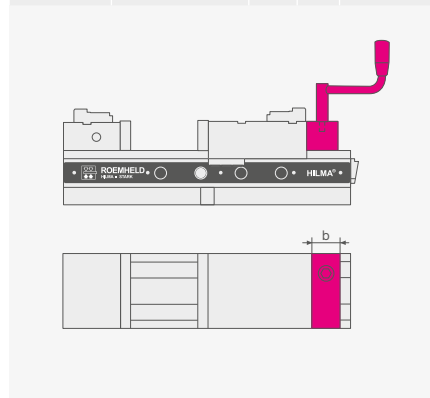



### Clamping force preselection, 6-stage

retrofitable for hydro-mechanical vices



Type	Part no.
NC 100	937620100
NC 125	937620125
NC 160	937620160

### Oil filling nipple

Retrofitable for mechanical/hydraulic design



Type	Part no.
NC 100	530900006
NC 125	
NC 160	530900007

### Load cell

for regularly checking the clamping force of hydraulic and mechanical clamping systems



Part no.	Display range [kN]
295010001	0–60

### Pump unit - for a single-acting clamping circuit

Flow rate: 0.82 l/min  
max. operating pressure: 350 bar  
Supply voltage: 3/PE 50Hz 400V  
Control voltage: 24 VDC

without valves and manual switch  
operation by valve with turning knob  
with pressure monitoring

Part no.
6810565

### Pump unit - for a single-acting clamping circuit

Flow rate: 0.82 l/min  
max. operating pressure: 350 bar  
Supply voltage: 3/PE 50Hz 400V  
Control voltage: 24 VDC

with 1 manual switch with approx. 3 m cable  
with pressure monitoring

Part no.
6810566

### Pump unit - for two single-acting clamping circuits

Flow rate: 0.82 l/min  
max. operating pressure: 350 bar  
Supply voltage: 3/PE 50Hz 400V  
Control voltage: 24 VDC

with 2 manual switches with approx. 3 m cable  
with pressure monitoring

Part no.
6810567

ROEMHELD power unit product range D 8.0115 ([www.roemheld-gruppe.de](http://www.roemheld-gruppe.de))

## INFO

### Hydraulic power unit

For the hydraulic supply and control of hydraulic clamping systems, we offer the suitable clamping power units. Completely equipped with the necessary electrical and hydraulic control, the desired operating element such as hand panel or foot switch as well as the integration into the machine control.

#### Basic unit without directional control valves and remote control

External control via rotary handle valves.

**1-circuit version**, for clamping and releasing one or more machine vices simultaneously. With plug-in remote control.

**2-circuit version**, for two separately controllable circuits (pendulum machining). With two remote controls.





## Order number list

6810565	41	930740913	17	937773311	39
6810566	41	930740914	17	938282660	30
6810567	41	930820203	19	938282670	30
295010001	41	930820303	19	938282680	30
420560019	40	930830203	20	938282682	30
420560020	40	930830303	20	938282691	30
420560021	40	930830403	20	938282701	30
420560022	40	930830803	20	939174121	39
420560022	40	930830903	20	939174141	39
420560023	40	930840203	21	930PNA100	22
420560031	40	930840303	21	930PNA125	22
520570021	40	930840803	21	930PNA160	22
520570022	40	930840903	21	S8000-300	37
520570023	40	932711201	26	S8000-301	37
520570024	40	932711301	26	S8000-302	37
520570025	40	932711401	26	S804-307	38
520570026	40	932721201	26	S804-470	37
520570027	40	932721301	26	S804-471	37
520570028	40	932721401	26	S804-472	37
530900006	41	932731201	27	S804-726	38
530900007	41	932731301	27	S804-727	38
550500099	31	932731401	27	S805-308	38
550500099	31	932741201	27		
550500123	31	932741301	27		
837711201	35	932741401	27		
837711301	35	932751201	28		
837711401	35	932751301	28		
837712201	35	932751401	28		
837712301	35	932843201	32		
837712401	35	932843301	32		
837714201	34	932843401	32		
837714301	34	932851201	33		
837714401	34	932851301	33		
837715201	35	932851401	33		
837715301	35	932861201	29		
837715401	35	932861301	29		
837717201	35	932861401	29		
837717301	35	932862201	29		
837717401	35	932862301	29		
930720203	15	932862401	29		
930720213	15	932863201	29		
930720214	15	932863301	29		
930720303	15	932863401	29		
930720313	15	932871201	27		
930720314	15	932871301	27		
930730203	16	932871401	27		
930730213	16	932910201	40		
930730214	16	932910401	40		
930730303	16	932940505	40		
930730313	16	932940605	40		
930730314	16	932940705	40		
930730403	16	937118011	28		
930730413	16	937118014	28		
930730414	16	937141201	31		
930730803	16	937141301	31		
930730813	16	937141401	31		
930730814	16	937142201	31		
930730903	16	937142301	31		
930730913	16	937142401	31		
930730914	16	937620100	41		
930740203	17	937620125	41		
930740213	17	937620160	41		
930740214	17	937710213	34		
930740303	17	937710313	34		
930740313	17	937710413	34		
930740314	17	937772011	39		
930740803	17	937773011	39		
930740813	17	937773021	39		
930740814	17	937773211	39		
930740903	17	937773231	39		

A COMPANY OF THE  
ROEMHELD GROUP

# STARK Spannsysteme

The ROEMHELD Group consists of 5 companies at locations in Germany and Austria, each with different products and orientations. With numerous subsidiaries, sales partners and service companies on all continents and in more than 50 countries, rapid and intensive customer support is provided in the mechanical engineering, medical technology, automotive, aviation and agricultural industries.

As part of the ROEMHELD Group, STARK benefits from the security and experience of a family-run traditional company as well as from the worldwide sales and service network. At the same time, this background provides the independence to pursue dynamic and innovative goals for new market-driven developments and customer-specific solutions with which STARK maintains its leading technological position.



**ROEMHELD**  
HILMA ■ STARK

## **STARK** Spannsysteme

A company of the ROEMHELD Group

STARK Spannsysteme GmbH  
Römergrund 14 | 6830 Rankweil  
Austria

+43 5522 37 400 - 0  
info@stark-roemheld.com

[stark-roemheld.com](http://stark-roemheld.com)