

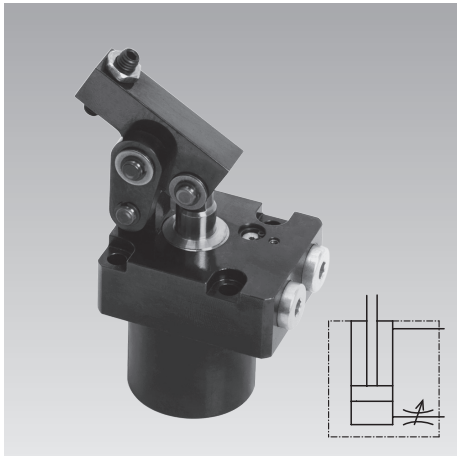

Hinge Clamps 70 bar
with throttle valve, metallic wiper edge and optional position monitoring
double acting, max. operating pressure 70 bar



Advantages

- High clamping force in the low-pressure range
- Very short clamping time (min. 0.5 s)
- Throttle valve as standard, easily adjustable from the top
- Compact design partially recessible
- Lever bolt plain bearing
- 3 clamping directions selectable
- Clamping possible without side loads
- Clamping lever can be swivelled into small recesses
- Long clamping lever adaptable to the work-piece contour
- FKM wiper protected by metallic wiper edge
- Position monitoring available as accessory
- Mounting position: any

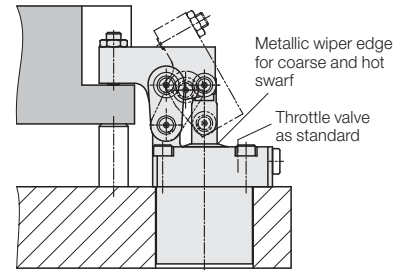

Application

Hydraulic hinge clamps are used for clamping of workpieces, when it is essential to keep the clamping area free of straps and clamping components for unrestricted workpiece loading and unloading.

A clamping recess in the workpiece a little bit wider than the clamping lever is sufficient as clamping surface.

The special kinematics allow clamping without side loads of workpieces which are very sensitive against deformation.

This series with an operating pressure of 70 bar is designed for the direct connection to the low-pressure hydraulics of machine tools.

In combination with the optional pneumatic or electrical position monitorings hinge clamps are particularly suitable for:

- Automatic manufacturing systems with very short cycle times
- Clamping fixtures with workpiece loading by handling systems
- Transfer lines
- Test systems for motors, gears and axes
- Assembly lines
- Special machine tools

Description

The hinge clamp is a double acting hydraulic cylinder with integrated clamping lever. When pressurising the element, the piston moves upwards and swivels the clamping lever over the hinges forwards and at the same time downwards onto the workpiece. The piston force is deviated by 180° and, depending on the lever length, the force is available as clamping force (see page 4). The kinematics are so designed that no side loads enter into the workpiece, if the clamping surface is at the same height as the centre of rotation of the clamping lever (see comparison "Forces at the clamping point").

The 3 available clamping directions (L, G, R) make it easier to adapt to the workpiece shape or the hydraulic connectivity.

All sizes are optionally available with switch rod for external position monitoring.

Electrical and pneumatic position monitorings for the clamping and unclamping position are available as accessories.

Forces at the clamping point

Conventional lever mechanism of other manufacturers

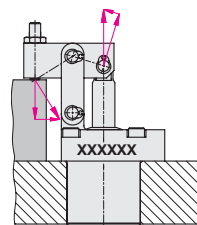

Lever mechanism without side loads ROEMHELD system

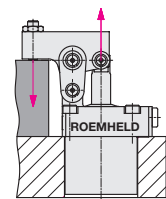

Installation and connecting possibilities

Pipe thread

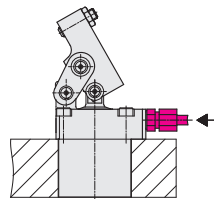

Drilled channels

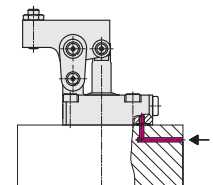

Versions

Without switch rod

(Option Long clamping lever)

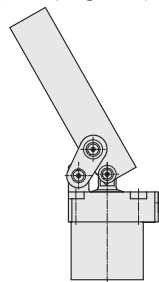

With switch rod

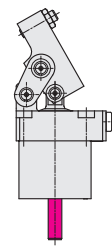

Clamping direction

Code letters

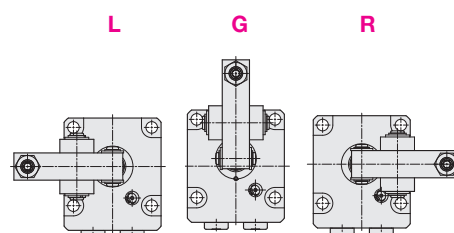

Accessories – position monitoring

pneumatic

electrical

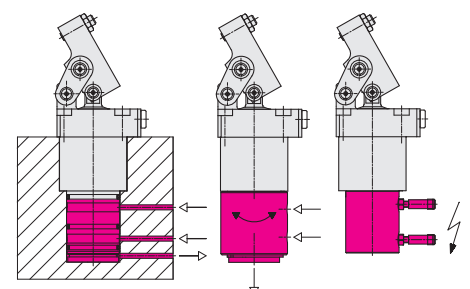

Important notes see page 6.

Versions: without / with switch rod
Dimensions • Accessories

Without switch rod
1826G7X31

Clamping lever with contact bolt

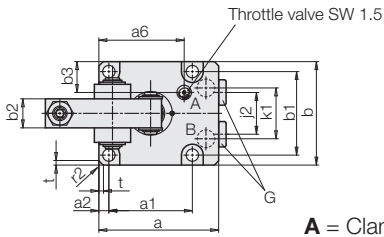
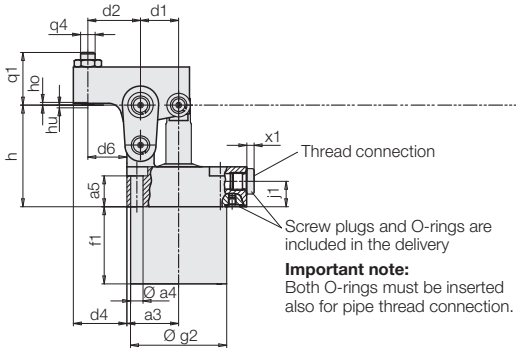

Connecting scheme

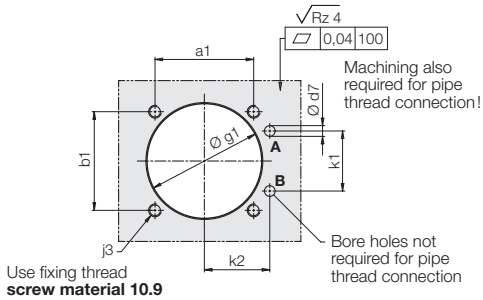

Clamping direction

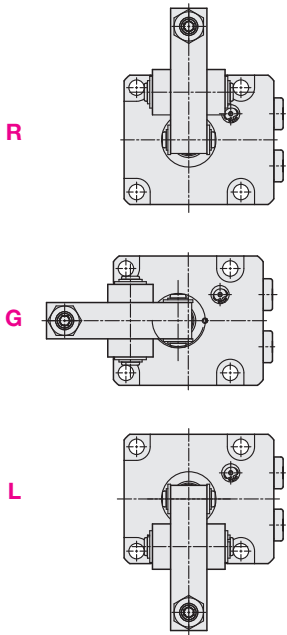

X = code letter for part no.

With switch rod
1826G7X40

Without clamping lever

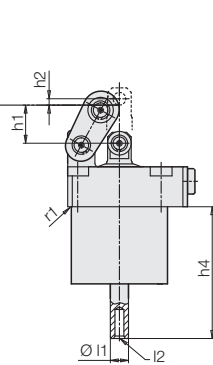

With switch rod
1826G7X41

Clamping lever with contact bolt

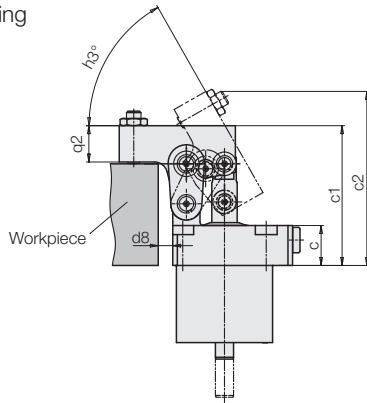

With switch rod
1826G7X42

Clamping lever, long

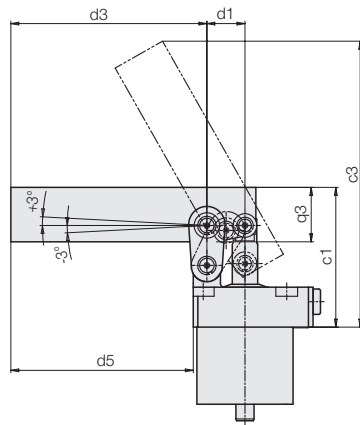

Connecting dimensions for
self-manufactured clamping levers

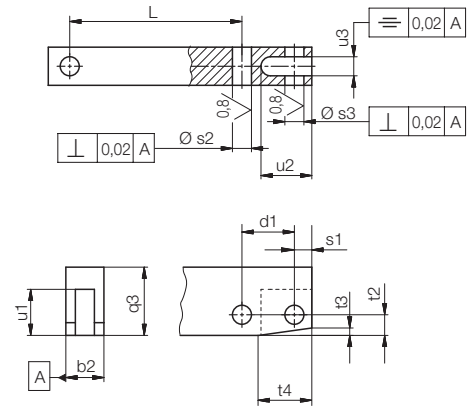

Accessories

Pneumatic position monitoring (page 5)
Cartridge type

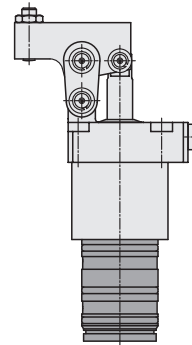

Pipe thread connection

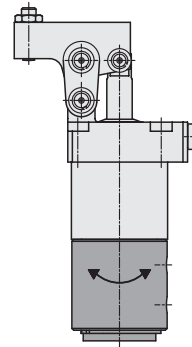

Inductive position monitoring (page 6)

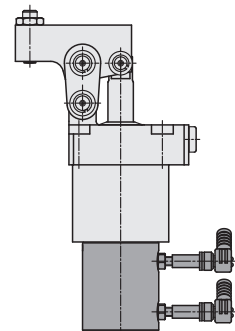

Technical data

Size		1	2	3	4	5	
Max. clamping force	at length of clamping lever d2						
	without switch rod	[kN]	2.6	3.5	4.4	7.3	12.1
Piston force	with switch rod	[kN]	2.3	3.1	4	6.8	11.5
	without switch rod	[kN]	3.4	4.9	6.7	10.6	17.2
	with switch rod	[kN]	3	4.3	6.1	9.8	16.4
		[kN]					
Piston Ø	[mm]	25	30	35	44	56	
Piston rod Ø	[mm]	12	14	14	16	22	
Piston stroke	[mm]	18.7	20.7	24	26	32	
Piston area	clamping						
	without switch rod	[cm ²]	4.9	7.06	9.62	15.2	24.6
	with switch rod	[cm ²]	4.4	6.28	8.83	14	23.4
	unclamping	[cm ²]	3.77	5.52	8.08	13.1	20.8
Oil volume	clamping						
	without switch rod	[cm ³]	9.2	14.7	23.1	39.6	78.8
	with switch rod	[cm ³]	8.3	13	21.2	36.6	75.2
	unclamping	[cm ³]	7.1	11.45	19.4	34.3	66.7
Max. flow rate		[cm ³ /s]	16	25	40	75	150
	a	[mm]	55	60	66	82	96
a1	[mm]	35	40	46	56	68	
a2	[mm]	5	5	5.5	7	9	
a3	[mm]	22.5	25	28.5	35	43	
Ø a4	[mm]	5.6	5.6	6.8	9	11	
a5	[mm]	18	17	17	20	20	
a6	[mm]	37.5	41	47	57	70.3	
b	[mm]	45	50	57	70	86	
b1	[mm]	35	40	46	56	68	
b2 – 0.05	[mm]	12	12	16	19	22	
b3	[mm]	15.5	14	17	20	24	
c	[mm]	22	20.8	22	26	32	
c1	[mm]	63.5	68.5	77	93	110	
c2	[mm]	79.8	85.5	97	116.5	138.9	
c3	[mm]	129.1	152.8	157.6	204	226.8	
d1	[mm]	16.5	18.5	21	24.5	30.5	
d2	[mm]	20	23.5	29	32	39	
d3	[mm]	88	110.5	108	148.5	159.5	
d4	[mm]	20	23	29.5	31.5	37.5	
d5	[mm]	82	104	100.5	138	147	
d6	[mm]	14	17	21.5	21.5	26.5	
Ø d7 max.	[mm]	4	4	4	6	6	
d8 min.	[mm]	3	4	7	7	8	
f1	[mm]	33.5	39.5	42.5	47	55	
G		G1/8	G1/8	G1/8	G1/4	G1/4	
Ø g1 max.	[mm]	40	48	54	64	79	
Ø g2 ±0.1	[mm]	39	47	53	63	78	
h	ideal clamping point	[mm]	48.5	51.5	56	67	79
ho	upper end of the clamping range	[mm]	1	1.2	1.5	1.8	2
hu	lower end of the clamping range	[mm]	1.1	1.3	1.5	1.7	2.1
h1	stroke up to the ideal clamping point	[mm]	15.7	17.7	21	23	29
h2	stroke up to the end of the clamping stroke	[mm]	3	3	3	3	3
h3		[°]	57.6	58.6	60.4	57.6	57.4
h4	unclamping position	[mm]	60.2	68.2	72.6	78.1	93.6
j1		[mm]	12.5	12.8	14	14	14
j2		[mm]	20	22	23	30	38
j3	fixing thread		M5	M5	M6	M8	M10
k1		[mm]	22	24	28	36	45
k2		[mm]	25	28	30.5	36	42
Ø l1 f7	[mm]	8	10	10	12	12	
l2			M5x15 deep	M6x11.5 deep	M6x11.5 deep	M8x16 deep	M8x16 deep
q1	[mm]	26	26	29	39	48	
q2	[mm]	14	16	20	25	30	
q3	[mm]	21.5	26	30	36.5	45	
q4			M6	M6	M8	M10	M12
r1	[mm]	0.4	0.4	0.4	0.4	0.4	
r2	[mm]	7	9	9	11	12	
s1	[mm]	5.5	6	6	7	10	
Ø s2 H7	[mm]	6	8	8	10	14	
Ø s3 H7	[mm]	6	6	7	8	12	
t	[mm]	2.4	3.9	2.5	4	4.7	
t2	[mm]	6.5	9	9	10.5	14	
t3	[mm]	4	3	4.3	5.1	6.6	
t4	[mm]	4	17	22	22	31	
u1	[mm]	14.5	17.5	17.5	19	28	
u2	[mm]	16	16.5	17	19	26	
u3 +0.1	[mm]	6.1	6.1	8.1	10.1	11.1	
x1	[mm]	4	4	4	5	5	
Weight	[kg]	1	1.2	1.5	2.6	4.5	
Part no. without switch rod							
without clamping lever			1826X7130	1826X7230	1826X7330	1826X7430	1826X7530
Clamping lever with contact bolt			1826X7131	1826X7231	1826X7331	1826X7431	1826X7531
Clamping lever, long			1826X7132	1826X7232	1826X7332	1826X7432	1826X7532
Part no. with switch rod							
without clamping lever			1826X7140	1826X7240	1826X7340	1826X7440	1826X7540
Clamping lever with contact bolt			1826X7141	1826X7241	1826X7341	1826X7441	1826X7541
Clamping lever, long			1826X7142	1826X7242	1826X7342	1826X7442	1826X7542
Spare O-ring		[mm]	7x1.5	7x1.5	7x1.5	8x1.5	8x1.5
Part no.			3000342	3000342	3000342	3000343	3000343

X = Code letter see page 2

Clamping force diagrams

Calculation of the clamping force

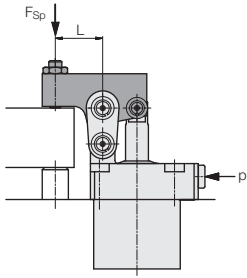

1. Length L of clamping lever is known

1.1 Admissible operating pressure

$$p = \frac{B}{(C/L) + 1} \leq 70 \text{ [bar]}$$

1.2 Effective clamping force

$$(p_{adm} > 70 \text{ bar}) \rightarrow F_{Sp} = \frac{A}{L} * 70 \text{ [kN]}$$

$$(p_{adm} > 70 \text{ bar}) \rightarrow F_{Sp} = \frac{A}{L} * p_{adm} \text{ [kN]}$$

2. Min. length of clamping lever

$$L_{min.} = \frac{C}{(B/p) - 1} \text{ [mm]}$$

L, L_{min.} = length of clamping lever [mm]

p, p_{adm.} = operating pressure [bar]

A, B, C, = constants as per chart

A*, B* for version with switch rod

	1826	71	72	73	74	75
A	0.73	1.18	1.82	3.35	6.76	
A*	0.65	1.05	1.67	3.11	6.45	
B	121.97	119.6	115.62	118.23	119.27	
B*	135.89	134.4	125.9	127.73	125	
C	14.85	16.65	18.9	22.05	27.45	

Eccentric clamping lever

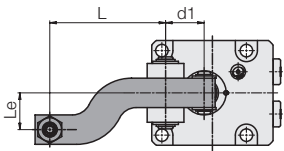

The diagrams show the admissible operating pressure for any combination of length L of clamping lever and the eccentricity Le.

$$\text{Formula } p_{adm} = \frac{X * L}{(Y * Le) + L + Z} \text{ [bar]}$$

L = length of clamping lever,

Le = eccentricity

X, Y, Z = constant as per chart

X* for version with switch rod

	1826	71	72	73	74	75
X	127.77	125.12	120.69	123.6	124.75	
X*	142.34	140.76	131.43	133.49	130.74	
Y	3.666	3.7	3.5	3.379	3.588	
Z	16.5	18.5	21	24.5	30.5	

Example: Hinge clamp 1826G72

Special clamping lever L = 60 mm

Eccentricity Le = 45 mm

As per diagram: p_{adm} = approx. 30 bar

According to formula:

$$p_{adm} = \frac{X * L}{(y * Le) + L + Z} = \frac{125.12 * 60}{(3.7 * 45) + 60 + 18.5}$$

$$p_{adm} = 30.64 \text{ bar}$$

Effective clamping force (formula see above)

$$F_{Sp} = \frac{A}{L} * p_{adm} = \frac{1.18}{60} * 30.64 = 0.6 \text{ kN}$$

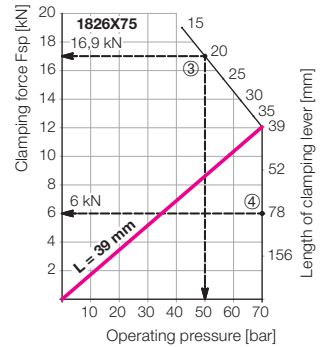
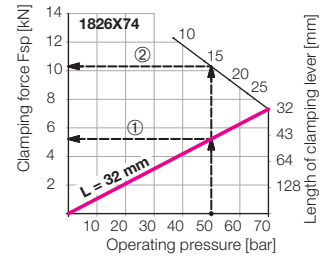
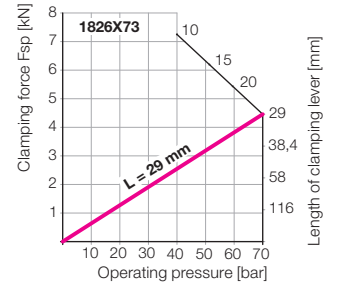
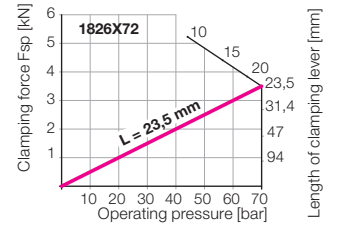
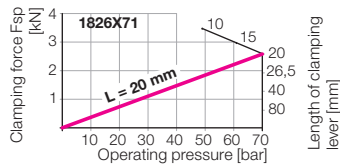

Example 1: Hinge clamp 1826G7432
p = 50 bar; L = 32 mm

Effective clamping force

$$F_{Sp} = \frac{A}{L} * p = \frac{3.35}{32} * 50 = 5.2 \text{ kN}$$

Example 2: Hinge clamp 1826G7432
p = 50 bar

Min. length of clamping lever

$$L_{min} = \frac{C}{(B/p) - 1} = \frac{22.05}{(118.23/50) - 1} = 16 \text{ mm}$$

Effective clamping force

$$F_{Sp} = \frac{A}{L} * p = \frac{3.35}{16} * 50 = 10.4 \text{ kN}$$

Example 3: Hinge clamp 1826G7532

Special clamping lever L = 20 mm

Admissible operating pressure

$$p_{adm} = \frac{B}{(C/L) + 1} = \frac{119.26}{(27.45/20) + 1} = 50.2 \text{ bar}$$

Effective clamping force

$$F_{Sp} = \frac{A}{L} * p_{adm} = \frac{6.76}{20} * 50.2 = 16.96 \text{ kN}$$

Example 4: Hinge clamp 1826G7532

Special clamping lever L = 78 mm

Admissible operating pressure

$$p_{adm} = \frac{B}{(C/L) + 1} = \frac{119.26}{(27.45/78) + 1} = 88.2 \text{ bar}$$

Effective clamping force

The max. operating pressure is 70 bar, thus

$$F_{Sp} = \frac{A}{L} * 70 = \frac{6.76}{78} * 70 = 6 \text{ kN}$$

Admissible operating pressure p_{adm} at eccentric location of the clamping point

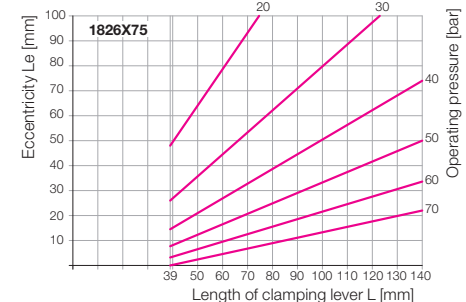
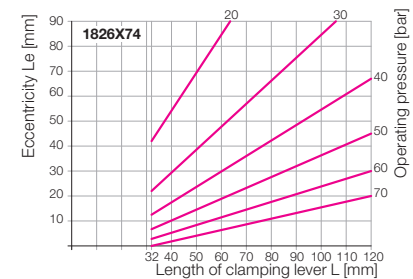
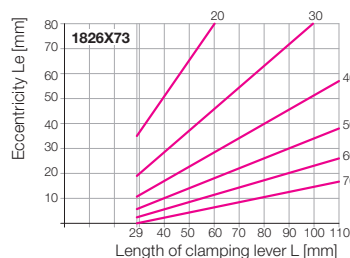
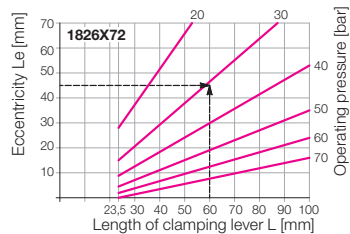
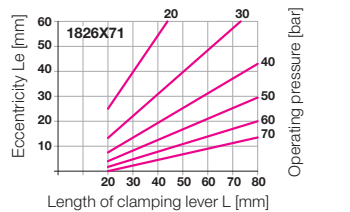

Important note

Depending on the eccentric load, there will be a one-sided wear of the bolts and an increasing torsion of the clamping lever around the longitudinal axis.

Recommendation: Regular visual inspection

Accessories

Pneumatic position monitoring (not adjustable)

Application

The pneumatic position monitoring signals the following conditions by closing two bore holes:

1. Piston retracted and clamping lever in off-position
2. Piston in clamping area and clamping lever in clamping position.

For each control function, a pneumatic line has to be provided at the clamping fixture.

Description

When moving to a switching position, the air pressure in the supply line increases and operates a differential pressure switch or an electro-pneumatic pressure switch.

Pneumatic port

Cartridge type

The hinge clamp with the mounted position monitoring and inserted O-rings is put into the location hole and immediately ready for use.

Mounting body

The mounting body is put onto the cartridge-type version and held by the supplied safety ring. The pneumatic ports M5 can be rotated by 360°.

Monitoring by pneumatic pressure switch

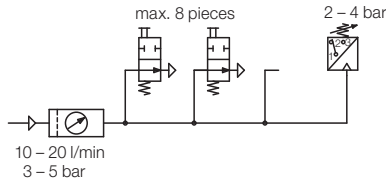

For the evaluation of the pneumatic pressure increase, standard pneumatic pressure switches can be used. With one pressure switch up to 8 position monitorings can be controlled (see circuit diagram).

It has to be considered that process-safe functioning of pneumatic controls is only guaranteed with throttled air pressure and air flow rate.

Technical data

Connection	Drilled channels or threads M5
Nominal diameter	2 mm
Max. air pressure	10 bar
Range of operating pressure	3...5 bar
Differential pressure*) at	
3 bar system pressure	min. 1.5 bar
5 bar system pressure	min. 3.5 bar
Air volume **)	10...20 l/min

*) Minimum pressure difference, if one or several position monitorings are not operated.

**) For measuring of the flow rate appropriate devices are available.

Function chart

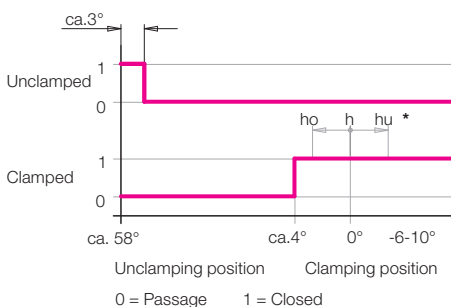

Cartridge type

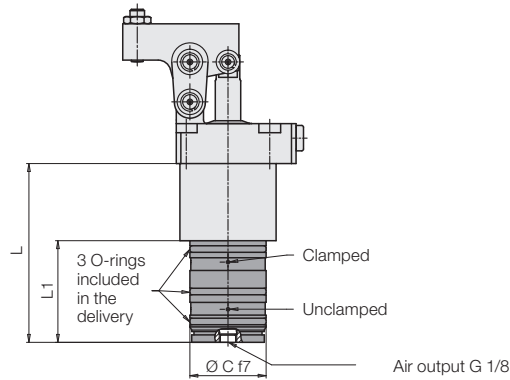

Pipe thread connection

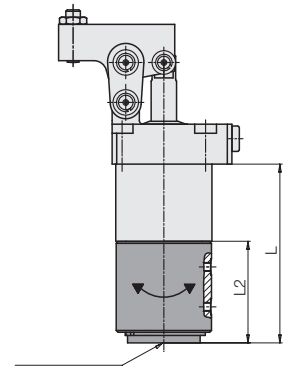

Location hole

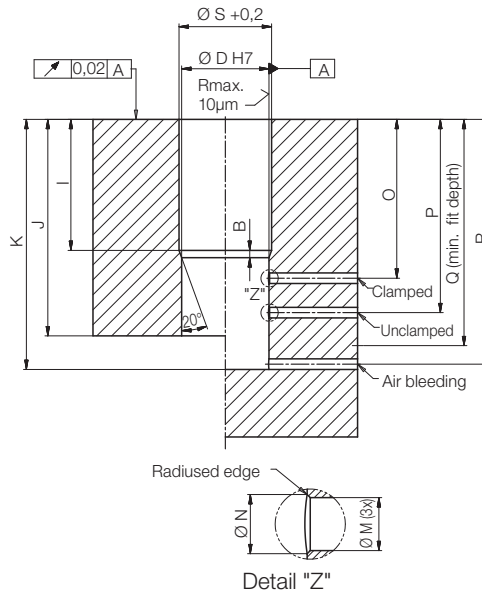

Mounting body

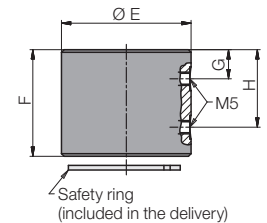

Size	1	2	3	4	5
Ø A ±0.1	39	47	53	63	78
B	1.3	2	2	2	2
Ø C f7	38	42	42	45	45
Ø D H7	38	42	42	45	45
Ø E	49	53	52.5	62.5	62.5
F	40.3	46	50	54	60
G	11	13	14	14	15
H	29.3	33	36	40	45
I +0.2	34	40	43	47.5	55.5
J min.	78	87	91	100	114
K min.	84	95	100	109	123
L	82.5	93.5	98.5	107	121.5
L1	49	54	56	60	66.5
L2	46.15	53.85	55.8	59.8	65.8
Ø M	4	4	4	4	4
Ø N	5	5	5	5	5
O	46	52	55.5	60	70.6
P	65	74	80	86	100.5
Q min.	77	85	90	98.5	113
R	79.5	90.5	95.5	104	118.5
Ø S max.	40	48	54	64	79

Part no.

Cartridge type	0353341	0353342	0353343	0353344	0353345
with 4 screws					
Mounting body	0353341A	0353342A	0353343A	0353344A	0353345A
for retrofitting of the cartridge type					

* Dimensions see page 2 and 3

Accessories

Electrical position monitoring • Important notes

Application

The electrical position monitoring signals the following conditions due to damping of two inductive proximity switches:

1. Piston retracted and clamping lever in off-position
2. Piston extended and clamping lever in off-position.

For each control function, an electrical line has to be provided at the clamping fixture.

Description

The electrical position monitoring can be easily retrofitted at all hinge clamps with switch rod (1826X7X4X).

Included in our delivery are:

- 1 Signal sleeve with screw
- 1 Adapter with 4 countersunk screws
- 1 Control housing with 3 set screws
- 2 Inductive proximity switches with right angle plug (if ordered)

The signal sleeve is screwed onto the switch rod. The adapter is mounted with 4 countersunk screws at the bottom cover.

The control housing can be put onto the adapter in any angular position and locked with 3 set screws.

For information on adjustment of proximity switches, see operating manual.

Important notes

Inductive position monitorings are not suitable for the use in coolant and swarf areas. According to the corresponding application conditions, safety measures have to be planned and checked later on.

Technical data

Operating voltage	10...30 V DC
Max. residual ripple	10%
Max. constant current	100 mA
Switching function	interlock
Output	PNP
Housing material	stainless steel
Thread	M 5 x 0.5
Code class	IP 67
Ambient temperature	-25...+70 °C
LED Function display	yes
Protected against short circuits	yes
Connection type	Plug
Length of cable	5 m

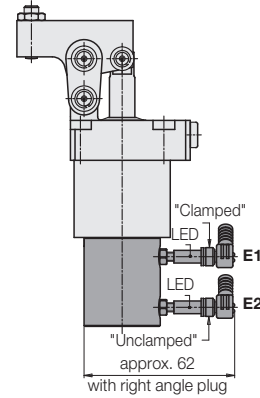
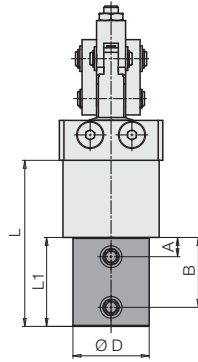

Four fixing screws included in our delivery

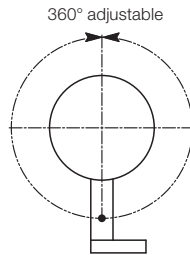

Possible position of the proximity switches

Size		1	2	3	4	5
A	[mm]	12.5	12.5	10.5	10	12
B	[mm]	35	37	38.5	42.5	50
Ø D	[mm]	33	42	42	45	45
L	[mm]	75.5	84.5	91.5	103.5	117
L1	[mm]	42	45	49	56.5	62
Part no.						
without switch		0353351	0353352	0353353	0353354	0353355
with switch and plug		0353351S	0353352S	0353353S	0353354S	0353355S
Spare parts						
Inductive proximity switch		3829198	3829198	3829198	3829198	3829198
Right angle plug with cable 5m		3829099	3829099	3829099	3829099	3829099

Function chart

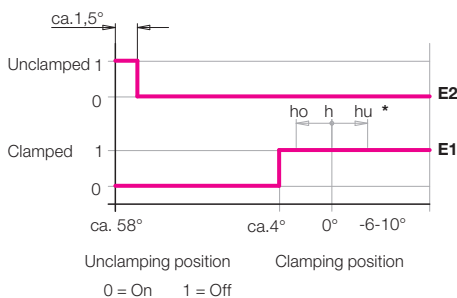

* Dimensions see page 2 and 3

Important notes

Hinge clamps must only be used for clamping of workpieces in industrial applications and may only be operated with hydraulic oil.

Hinge clamps can generate very high forces. The workpiece, the fixture or the machine must be in the position to compensate these forces. Considerable injuries can be caused to fingers during clamping and unclamping in the effective area of the clamping lever.

The manufacturer of the fixture or the machine is obliged to provide effective protection devices. Hinge clamps have to be checked regularly on contamination by swarf and have to be cleaned. Operating conditions, tolerances and other data see data sheet A 0.100.