

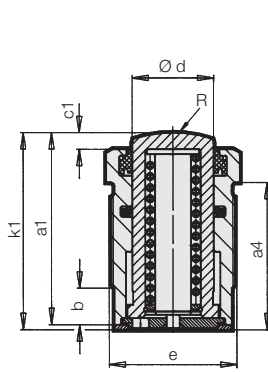

Threaded-Body Cylinder
single acting with spring return and double wiper
max. operating pressure 500 bar



Version without female thread



Version with female thread

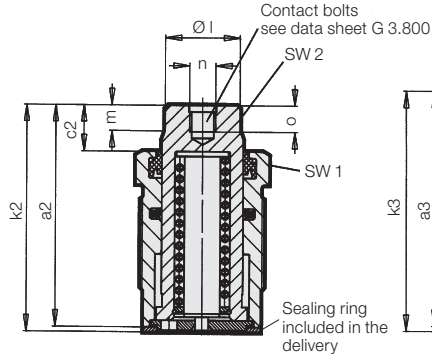

Version with swivel contact bolt

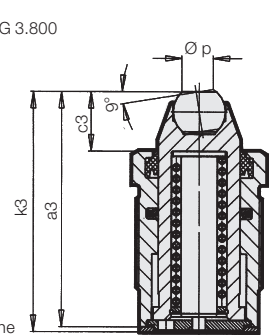

Description

These threaded-body cylinders can be threaded directly into tapped holes in the fixture down to the hex-section of the cylinder body. Spacings between cylinders can be minimised when cylinders are arranged in a row, since the oil is fed through drilled passages in the fixture. Sealing is made with the supplied sealing ring at the bottom of the location hole.

The plunger construction impedes penetration of fluids into the spring area.

The double wiper protects the piston guide and in combination with the piston rod seal provides a seal with very little leakage.

Material

Piston material: casehardening steel, hardened
Cylinder body: free-cutting steel

Important notes!

Threaded-body cylinders must not be subjected to a load in retracted position.

Operating conditions, tolerances and other data see data sheet A 0.100.

Accessories and application examples

see reverse page

Piston Ø d	[mm]	12	16	20	25	32
Stroke	[mm]	10	12	15	16	20
Clamping force at 100 bar	[kN]	1.1	2.0	3.1	4.9	8
Clamping force at 500 bar	[kN]	5.7	10.1	15.7	24.6	40
Spring return force, min.	[N]	28	50	78	123	200
Min. operating pressure	[bar]	10	10	10	10	10
Oil volume per 10 mm stroke	[cm³]	1.13	2.01	3.14	4.91	8.04
a1	[mm]	37	45.5	55	58	85
a2	[mm]	44	51.5	64.5	67	96
a3	[mm]	44.5	53	68.5	71	98
a4	[mm]	25	33	42	44.5	71.5
b	[mm]	7	8	8	11	12
c1	[mm]	3	3.5	4	5	7
c2	[mm]	10	9.5	13.5	14	18
c3	[mm]	10.5	11	17.5	18	20
Ø d	[mm]	12	16	20	25	32
e	[mm]	M22x1.5	M26x1.5	M30x1.5	M38x1.5	M48x1.5
f min./max.	[mm]	16/24.5	20/32.5	24/41.5	28/44	42/70
g max.	[mm]	8	9	9	11	13
Ø h min./max.	[mm]	9/12	12/16	14/20	18/25	22/32
i min.	[mm]	31	34	40	52	62
k1	[mm]	38	46.5	56	59.5	87
k2	[mm]	45	52.5	65.5	68.5	98
k3	[mm]	45.5	54	69.5	72.5	100
Ø l	[mm]	11	15	19	23	30
m	[mm]	5.5	5.5	6	7	9
n	[mm]	M6	M6	M8	M8	M12
o	[mm]	6	6	8	8	12
Ø p	[mm]	7.2	7.2	10.5	10.5	20.0
R	[mm]	20	25	32	40	50
SW 1	[mm]	24	27	32	41	50
SW 2	[mm]	10	13	17	19	24
Seating torque	[Nm]	40	50	60	80	225
Weight	[kg]	0.08	0.15	0.22	0.38	0.97

Part no.

Version without female thread	1460100	1461100	1462100	1463100	1464100
Version with female thread	1460101	1461101	1462101	1463101	1464101
Version with swivel contact bolt	1460110	1461110	1462110	1463110	1464110
Additional seal	3000840	3000841	3000842	3000843	3000527

Porting details

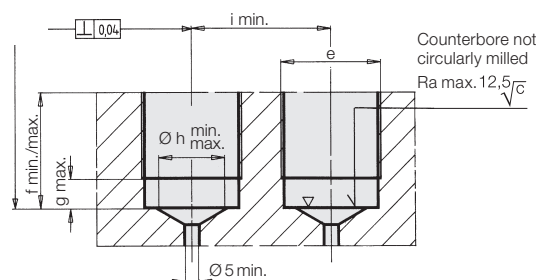

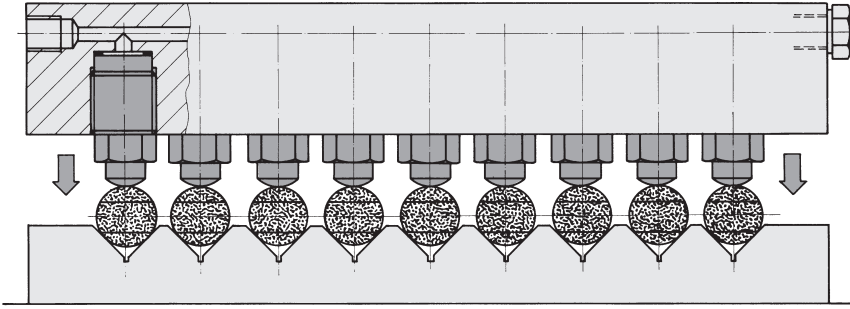

The opposite figure shows a multiple clamping fixture for clamping of small parts. The cylinders can be arranged in a clamping bar or yoke.

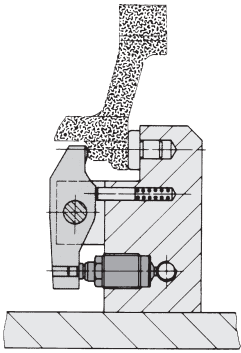
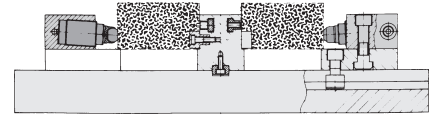

Workholding with the use of reversing levers is particularly suited for workpieces which have to be clamped high above the fixture base plate. The force-loop closed within a limited fixture component space eliminates bending forces from entering the fixture base plate. The reversing lever allows easy adaptation of the lever ratio to the clamping force required.

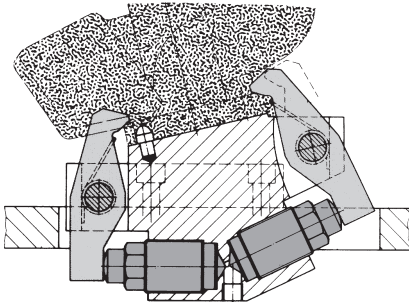

This example shows a detail of a clamping fixture for exhaust manifolds, where under limited space conditions the use of reversing levers allows clamping of workpieces with intricate contours.

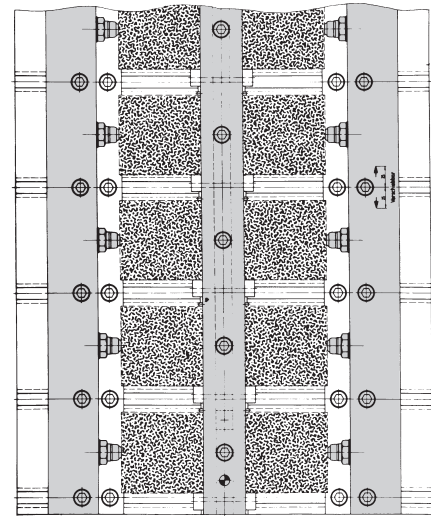

The above multiple clamping fixture is equipped with threaded-body cylinders with swivel contact bolts. The 3° incline of the threaded-body cylinders effects a low-clamping force of approx. 5% of the clamping force. On plane clamping surfaces swivel contact bolts obtain little surface pressure on the effective points.